

- ① Fissare la staffa a parete. (utilizzare tasselli appropriati in base al tipo di muro)
Fix the bracket on the wall. (use appropriate anchors depending on the type of wall)

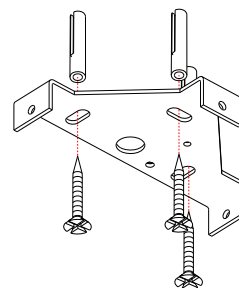

- ② Eseguire il cablaggio come illustrato nello schema.
Carry out the wirings as shown in the diagram.

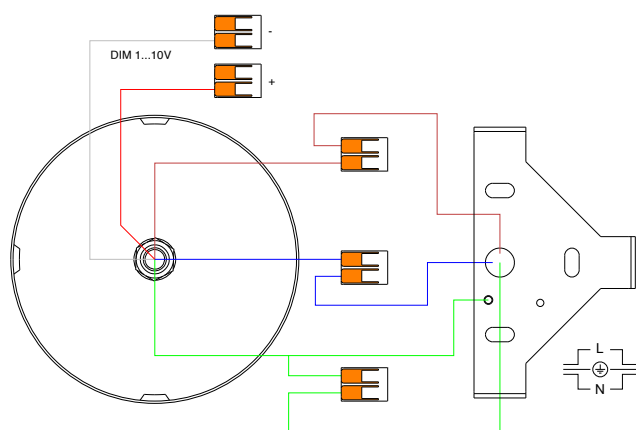

CE

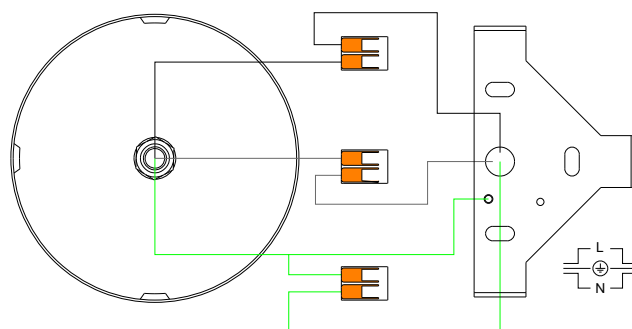

USA

- ③ Per regolare la lunghezza del cavo svitare il grano illustrato nello schema. Una volta definita la lunghezza desiderata avvitare nuovamente il grano.
In order to adjust the length of the cable, unscrew the dowel shown in the diagram. Once the desired length has been defined, screw the dowel again.

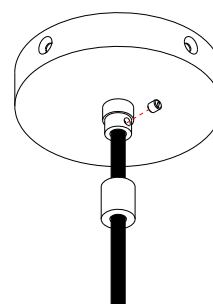

- ④ Fissare il rosone alla staffa utilizzando le viti fornite.
Secure the canopy to the bracket using the screws provided.

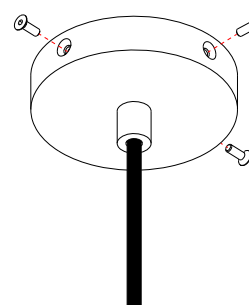

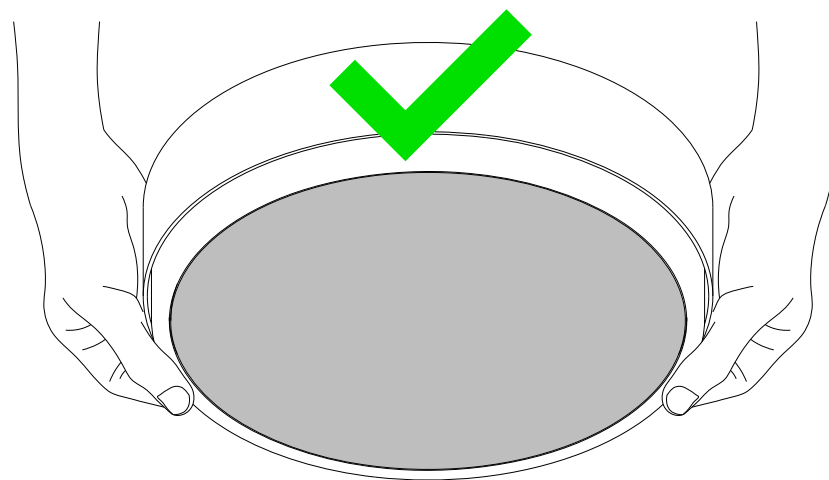
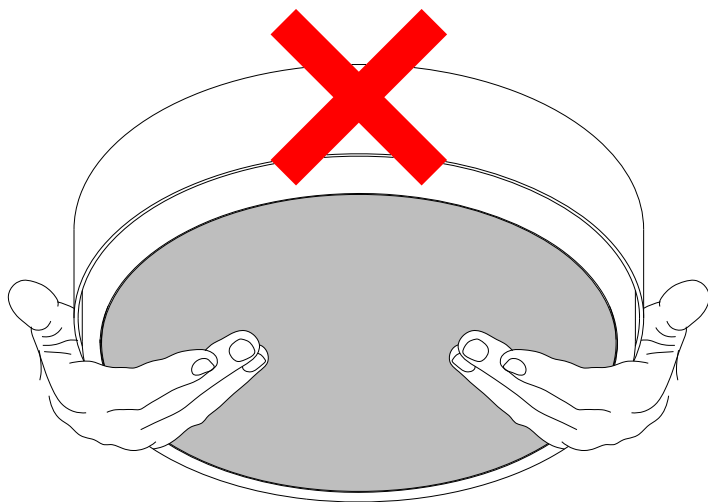

 Nel maneggiare le lampade Discus assicurarsi di non afferrarle mai da sotto facendo pressione sul disco diffusore in plexiglass. Maneggiare le lampade sempre afferrando la struttura metallica della lampada.

When handling the Discus lamps, make sure you never grab them from underneath by pressing on the plexiglass diffuser disc. Always handle the lamps by grasping the metal structure of the lamp.