

TECHNICAL DATA SHEET

MINI RECTANGLE IP20

INDOOR

Fix (not adjustable) 0° - 0°

 102x238 mm

Material : CALCYT® plaster

MINI SQUARE IP20

INDOOR

Fix (not adjustable) 0° - 0°

 102x190 mm

Material : CALCYT® plaster

MINI LED DIM 100 LM







REF N° 149 60 500 CRI 80 warm white 2200°K

REF N° 149 60 000 CRI 90 warm white 2700°K

REF N° 149 60 100 CRI 90 warm white 3000°K

REF N° 149 60 200 CRI 90 neutral white 4000°K

REF N° 149 60 300 royal blue

 - 1W - excl. LED driver - current controlled 350 mA -  -  -  -  -  - serial wiring - 3 Step MacAdam
Requires remote LED driver - 350 mA

MINI SQUARE LED DIM 100 LM







REF N° 150 60 500 CRI 80 warm white 2200°K

REF N° 150 60 000 CRI 90 warm white 2700°K

REF N° 150 60 100 CRI 90 warm white 3000°K

REF N° 150 60 200 CRI 90 neutral white 4000°K

REF N° 150 60 300 royal blue

 - 1W - excl. LED driver - current controlled 350 mA -  -  -  -  -  - serial wiring - 3 Step MacAdam
Requires remote LED driver - 350 mA

MINI LED DIM 200 LM







REF N° 149 62 500 CRI 80 warm white 2200°K

REF N° 149 62 000 CRI 90 warm white 2700°K

REF N° 149 62 100 CRI 90 warm white 3000°K

REF N° 149 62 200 CRI 90 neutral white 4000°K

REF N° 149 62 300 royal blue

 - 2W - excl. LED driver - current controlled 350 mA -  -  -  -  -  - serial wiring - 3 Step MacAdam
Requires remote LED driver - 350 mA

MINI SQUARE LED DIM 200 LM







REF N° 150 62 500 CRI 80 warm white 2200°K

REF N° 150 62 000 CRI 90 warm white 2700°K

REF N° 150 62 100 CRI 90 warm white 3000°K

REF N° 150 62 200 CRI 90 neutral white 4000°K

REF N° 150 62 300 royal blue

 - 2W - excl. LED driver - current controlled 350 mA -  -  -  -  -  - serial wiring - 3 Step MacAdam
Requires remote LED driver - 350 mA

MINI LED DIM 400 LM







REF N° 149 61 500 CRI 80 warm white 2200°K

REF N° 149 61 000 CRI 90 warm white 2700°K

REF N° 149 61 100 CRI 90 warm white 3000°K

REF N° 149 61 200 CRI 90 neutral white 4000°K

REF N° 149 61 300 royal blue

 - 4W - excl. LED driver - current controlled 350 mA -  -  -  -  -  - serial wiring - 3 Step MacAdam
Requires remote LED driver - 350 mA

MINI SQUARE LED DIM 400 LM







REF N° 150 61 500 CRI 80 warm white 2200°K

REF N° 150 61 000 CRI 90 warm white 2700°K

REF N° 150 61 100 CRI 90 warm white 3000°K

REF N° 150 61 200 CRI 90 neutral white 4000°K

REF N° 150 61 300 royal blue

 - 4W - excl. LED driver - current controlled 350 mA -  -  -  -  -  - serial wiring - 3 Step MacAdam
Requires remote LED driver - 350 mA

MINI RECTANGLE IP20

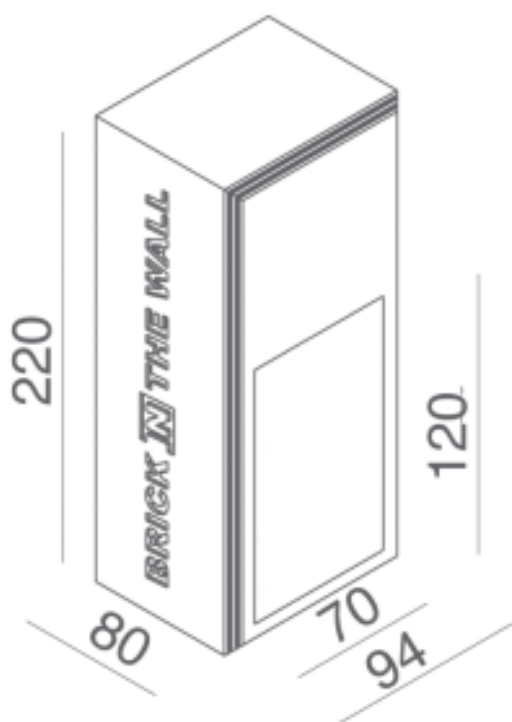

Ready for installation in solid walls
Optional plasterkit for installation into gypsum walls

PLASTERKIT MINI

REF N° 749 01 000 For mounting into gypsum walls

MINI SQUARE IP20

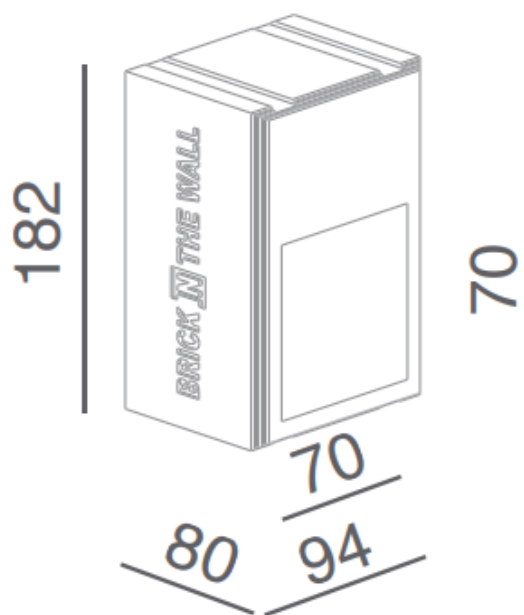

Ready for installation in solid walls
Optional plasterkit for installation into gypsum walls

PLASTERKIT MINI SQUARE

REF N° 750 01 000 For mounting into gypsum walls