

# TECHNICAL DATA SHEET

## MINI RECTANGLE IP54

BATHROOM

Fix (not adjustable) 0° - 0°

 102×238 mm

Material : CALCYT® plaster

## MINI SQUARE IP54

BATHROOM

Fix (not adjustable) 0° - 0°

 102×190 mm

Material : CALCYT® plaster

### MINI LED DIM 100 LM





REF N° 149 60 501 CRI 80 warm white 2200°K

REF N° 149 60 001 CRI 90 warm white 2700°K

REF N° 149 60 101 CRI 90 warm white 3000°K

REF N° 149 60 201 CRI 90 neutral white 4000°K

REF N° 149 60 301 royal blue

 - 1W - excl. LED driver - current controlled 350 mA -  -  -   
CE -  - serial wiring - 3 Step MacAdam  
Requires remote LED driver - 350 mA

### MINI SQUARE LED DIM 100 LM





REF N° 150 60 501 CRI 80 warm white 2200°K

REF N° 150 60 001 CRI 90 warm white 2700°K

REF N° 150 60 101 CRI 90 warm white 3000°K

REF N° 150 60 201 CRI 90 neutral white 4000°K

REF N° 150 60 301 royal blue

 - 1W - excl. LED driver - current controlled 350 mA -  -  -   
CE -  - serial wiring - 3 Step MacAdam  
Requires remote LED driver - 350 mA

### MINI LED DIM 200 LM





REF N° 149 62 501 CRI 80 warm white 2200°K

REF N° 149 62 001 CRI 90 warm white 2700°K

REF N° 149 62 101 CRI 90 warm white 3000°K

REF N° 149 62 201 CRI 90 neutral white 4000°K

REF N° 149 62 301 royal blue

 - 2W - excl. LED driver - current controlled 350 mA -  -  -   
CE -  - serial wiring - 3 Step MacAdam  
Requires remote LED driver - 350 mA

### MINI SQUARE LED DIM 200 LM





REF N° 150 62 501 CRI 80 warm white 2200°K

REF N° 150 62 001 CRI 90 warm white 2700°K

REF N° 150 62 101 CRI 90 warm white 3000°K

REF N° 150 62 201 CRI 90 neutral white 4000°K

REF N° 150 62 301 royal blue

 - 2W - excl. LED driver - current controlled 350 mA -  -  -   
CE -  - serial wiring - 3 Step MacAdam  
Requires remote LED driver - 350 mA

### MINI LED DIM 400 LM





REF N° 149 61 501 CRI 80 warm white 2200°K

REF N° 149 61 001 CRI 90 warm white 2700°K

REF N° 149 61 101 CRI 90 warm white 3000°K

REF N° 149 61 201 CRI 90 neutral white 4000°K

REF N° 149 61 301 royal blue

 - 4W - excl. LED driver - current controlled 350 mA -  -  -   
CE -  - serial wiring - 3 Step MacAdam  
Requires remote LED driver - 350 mA

### MINI SQUARE LED DIM 400 LM





REF N° 150 61 501 CRI 80 warm white 2200°K

REF N° 150 61 001 CRI 90 warm white 2700°K

REF N° 150 61 101 CRI 90 warm white 3000°K

REF N° 150 61 201 CRI 90 neutral white 4000°K

REF N° 150 61 301 royal blue

 - 4W - excl. LED driver - current controlled 350 mA -  -  -   
CE -  - serial wiring - 3 Step MacAdam  
Requires remote LED driver - 350 mA

## MINI RECTANGLE IP20

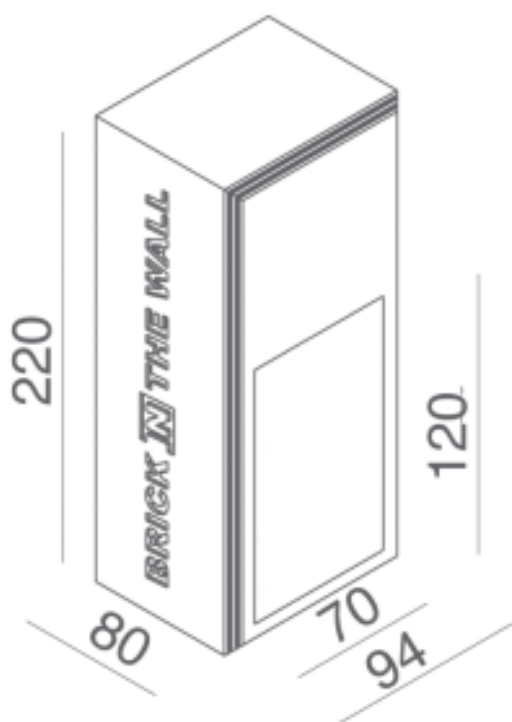

Ready for installation in solid walls  
Optional plasterkit for installation into gypsum walls

### PLASTERKIT MINI

REF N° 749 01 000 For mounting into gypsum walls

## MINI SQUARE IP20

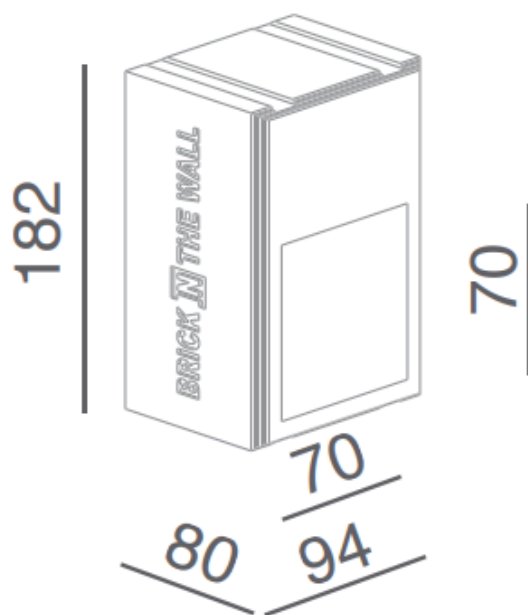

Ready for installation in solid walls  
Optional plasterkit for installation into gypsum walls

### PLASTERKIT MINI SQUARE

REF N° 750 01 000 For mounting into gypsum walls