

Mizu, Flowing *Light*.

design Nicolas Terzani
terzani.com



TERZANI
LA LUCE PENSATA



Type |
Pendant

Materials |
Clear crystal

Finishes | Code

-  Clear
OR01S H4 A9
-  Clear/Silver Dust
OR01S H4 F4
-  Clear/Gold
OR01S E8 A4

Available with White or
Brushed nickel canopy

Body |

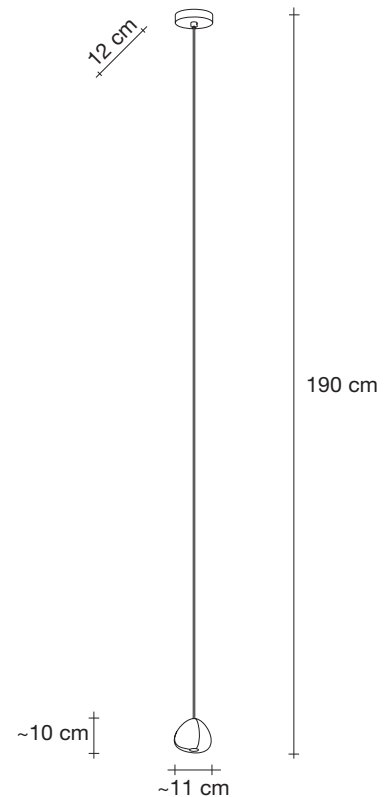



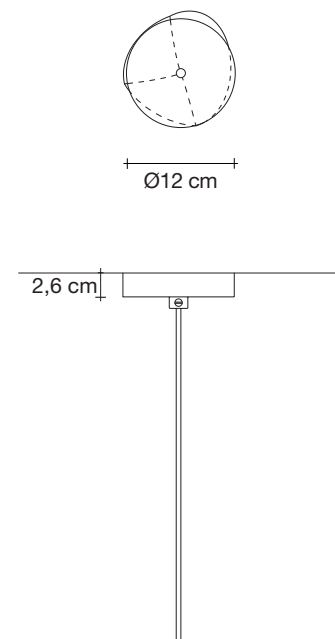



Canopy |



Light Source |

230-240V ~ 50/60Hz

-  HALOGEN
10W G4 12V
-  Dimmable with IGBT
Dali system on request
- or on request**
-  LED
2W G4 12V
-  Not Dimmable
Dali system on request
-  LED integrated
1,5W
-  Not Dimmable

Inspired by the tranquil and mesmerizing light refractions created by water, Mizu is a customizable pendant light from Terzani. Like water droplets, no two Mizu are alike, each crystal shape is unique and made meticulously by hand. Using only the clearest crystal, Mizu perfectly emulates water's refraction of light, casting amazing patterns around the room, reminiscent of flowing water. Also available in gold leaf. Design Nicolas Terzani

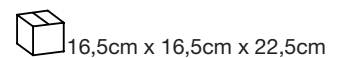

Mizu, Flowing *Light*.



design Nicolas Terzani
terzani.com



Type |
Suspension

Materials |
Clear crystal

Finishes | Code

-  Clear
OR03S H4 A9
-  Clear/Silver Dust
OR03S H4 F4
-  Clear/Gold
OR03S E8 A4

Available with White or
Brushed nickel canopy



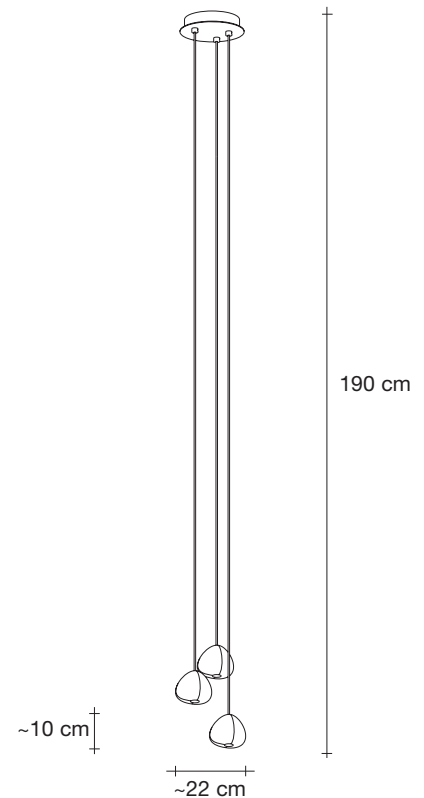



Body |



Canopy |

Light Source |

230-240V ~ 50/60Hz

-  HALOGEN
3 x 10W G4 12V
-  Dimmable with IGBT and TRIAC
Dali system on request
- or on request
-  LED
3 x 2W G4 12V
-  Dimmable with IGBT
Dali system on request
-  LED integrated
3 x 1,5W
-  Dimmable with 1-10V
Dali system on request



Inspired by the tranquil and mesmerizing light refractions created by water, Mizu is a customizable pendant light from Terzani. Like water droplets, no two Mizu are alike, each crystal shape is unique and made meticulously by hand. Using only the clearest crystal, Mizu perfectly emulates water's refraction of light, casting amazing patterns around the room, reminiscent of flowing water. Also available in gold leaf. Design Nicolas Terzani

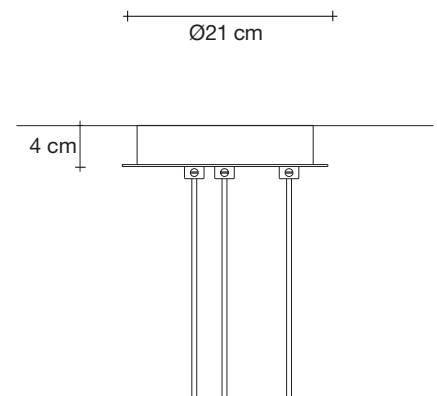
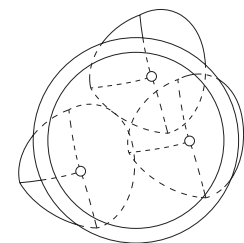

10



8



31cm x 31cm x 26cm

Mizu, Flowing *Light*.



design Nicolas Terzani
terzani.com



Type |
Suspension

Materials |
Clear crystal

Finishes | Code

-  Clear
OR05S H4 A9
-  Clear/Silver Dust
OR05S H4 F4
-  Clear/Gold
OR05S E8 A4





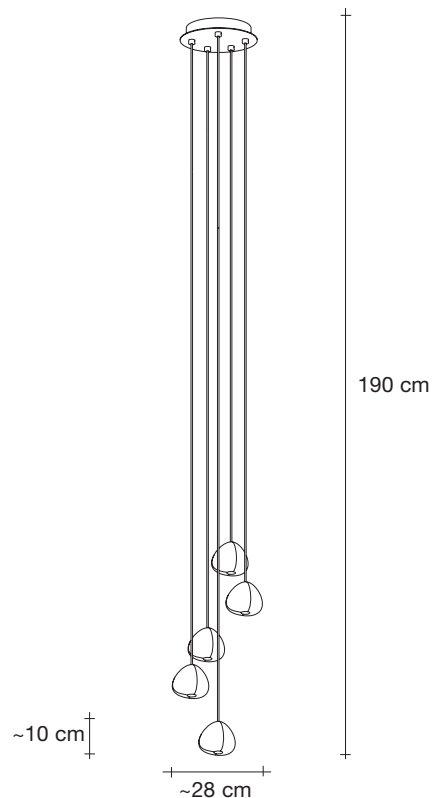

Available with White or
Brushed nickel canopy

Body |



Light Source |

230-240V ~ 50/60Hz

-  HALOGEN
5 x 10W G4 12V
-  Dimmable with IGBT and TRIAC
Dali system on request
-
- or on request**
-  LED
5 x 2W G4 12V
-  Dimmable with IGBT
Dali system on request
-
-  LED integrated
5 x 1,5W
-  Dimmable with 1-10V
Dali system on request

Canopy |

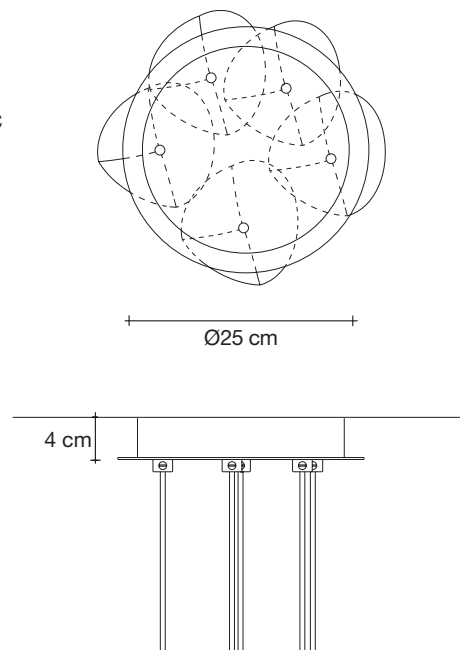

Inspired by the tranquil and mesmerizing light refractions created by water, Mizu is a customizable pendant light from Terzani. Like water droplets, no two Mizu are alike, each crystal shape is unique and made meticulously by hand. Using only the clearest crystal, Mizu perfectly emulates water's refraction of light, casting amazing patterns around the room, reminiscent of flowing water. Also available in gold leaf. Design Nicolas Terzani



15



12



47,5cm x 31,5cm x 27,5cm

Mizu, Flowing *Light*.



design Nicolas Terzani
terzani.com



Type |
Suspension

Materials |
Clear crystal

Finishes | Code

-  Clear
OR07S H4 A9
-  Clear/Silver Dust
OR07S H4 F4
-  Clear/Gold
OR07S E8 A4



Available with White or
Brushed nickel canopy

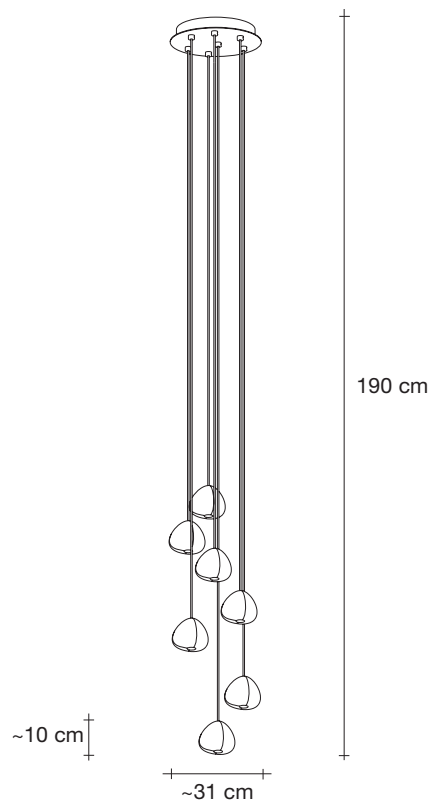



Body |



Light Source |

230-240V ~ 50/60Hz

-  HALOGEN
7 x 10W G4 12V
-  Dimmable with IGBT and TRIAC
Dali system on request
- **or on request**

-  LED
7 x 2W G4 12V
-  Dimmable with IGBT
Dali system on request
-
-  LED integrated
7 x 1,5W
-  Dimmable with 1-10V
Dali system on request

Canopy |

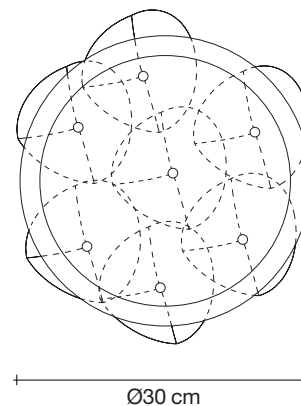

Inspired by the tranquil and mesmerizing light refractions created by water, Mizu is a customizable pendant light from Terzani. Like water droplets, no two Mizu are alike, each crystal shape is unique and made meticulously by hand. Using only the clearest crystal, Mizu perfectly emulates water's refraction of light, casting amazing patterns around the room, reminiscent of flowing water. Also available in gold leaf. Design Nicolas Terzani

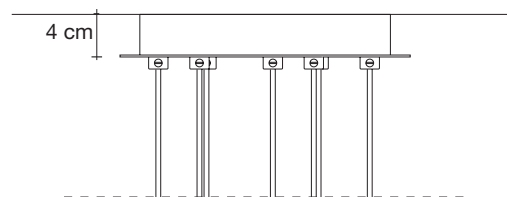

19



15



50cm x 35cm x 38cm

Mizu, Flowing *Light*.



design Nicolas Terzani
terzani.com



Type |
Suspension

Materials |
Clear crystal

Finishes | Code

-  Clear
OR15S E8 A9 R
-  Clear/Silver Dust
OR15S E8 F4 R
-  Clear/Gold
OR15S E8 A4 R





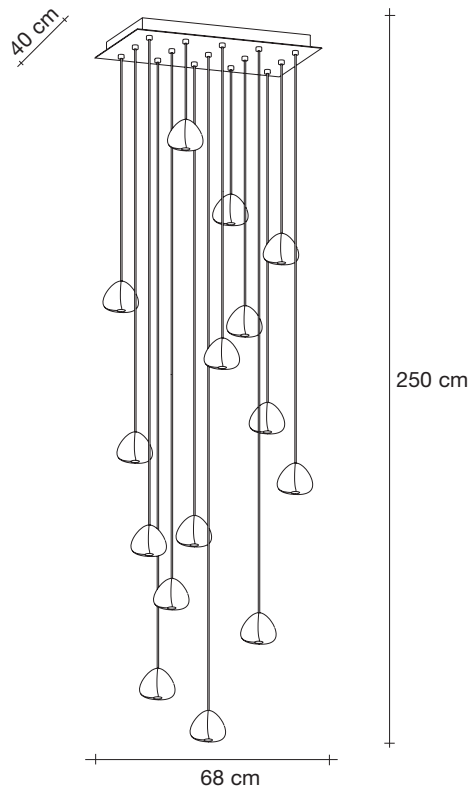

White canopy

Body |



Light Source |

230-240V ~ 50/60Hz

-  HALOGEN
15 x 10W G4 12V
-  Dimmable with IGBT and TRIAC
Dali system on request
- or on request
-  LED
15 x 2W G4 12V
-  Dimmable with IGBT
Dali system on request
-  LED integrated
15 x 1,5W
-  Dimmable with 1-10V
and Dali

Canopy |

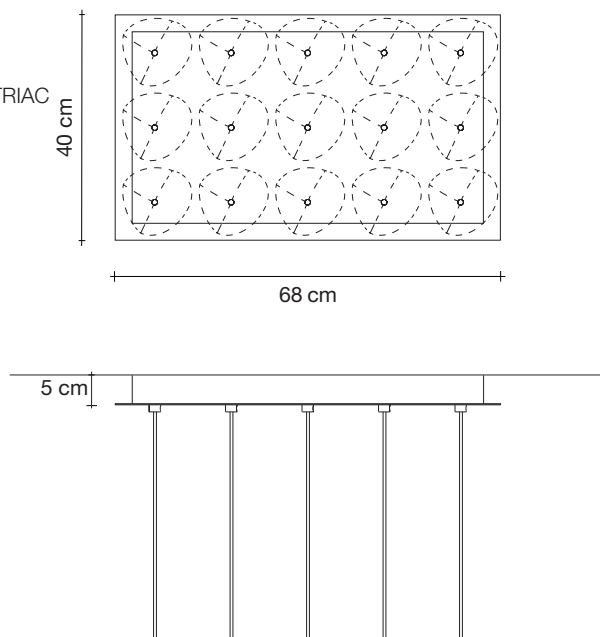

Inspired by the tranquil and mesmerizing light refractions created by water, Mizu is a customizable pendant light from Terzani. Like water droplets, no two Mizu are alike, each crystal shape is unique and made meticulously by hand. Using only the clearest crystal, Mizu perfectly emulates water's refraction of light, casting amazing patterns around the room, reminiscent of flowing water. Also available in gold leaf. Design Nicolas Terzani



40



36



77cm x 77cm x 30cm

Mizu, Flowing *Light*.



design Nicolas Terzani
terzani.com



Type |
Suspension

Materials |
Clear crystal

Finishes | Code

-  Clear
OR15S E8 A9 T
-  Clear/Silver Dust
OR15S E8 F4 T
-  Clear/Gold
OR15S E8 A4 T

White canopy

Body |

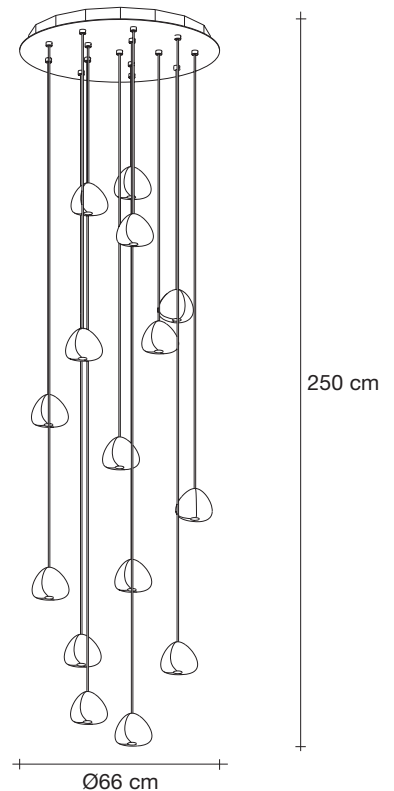



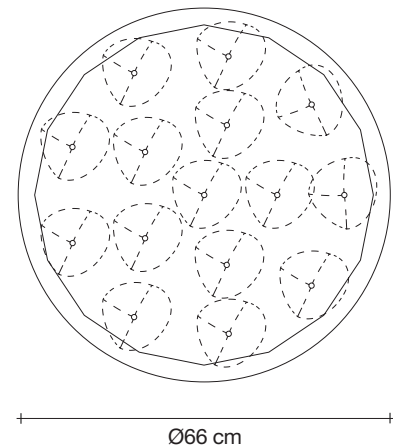



Canopy |



Light Source |

230-240V ~ 50/60Hz

-  HALOGEN
15 x 10W G4 12V
-  Dimmable with IGBT and TRIAC
Dali system on request
- or on request
-  LED
15 x 2W G4 12V
-  Dimmable with IGBT
Dali system on request
-  LED integrated
15 x 1,5W
-  Dimmable with 1-10V
and Dali

Inspired by the tranquil and mesmerizing light refractions created by water, Mizu is a customizable pendant light from Terzani. Like water droplets, no two Mizu are alike, each crystal shape is unique and made meticulously by hand. Using only the clearest crystal, Mizu perfectly emulates water's refraction of light, casting amazing patterns around the room, reminiscent of flowing water. Also available in gold leaf. Design Nicolas Terzani

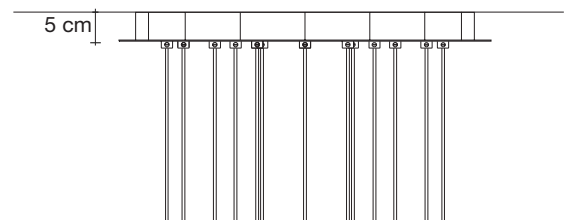

40



36



77cm x 77cm x 30cm

Mizu, Flowing *Light.*



design Nicolas Terzani
terzani.com



Type |
Suspension

Materials |
Clear crystal

Finishes | Code

-  Clear
OR26S E8 A9 Q
-  Clear/Silver Dust
OR26S E8 F4 Q
-  Clear/Gold
OR26S E8 A4 Q





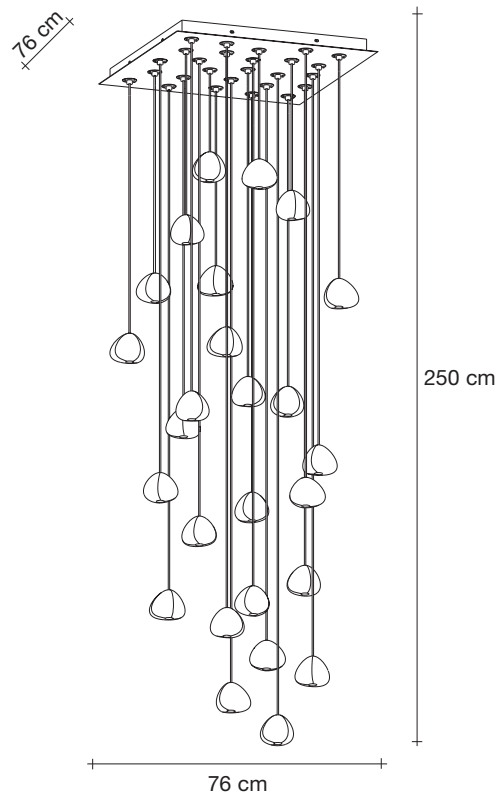

White canopy

Body |



Light Source |

230-240V ~ 50/60Hz

-  HALOGEN
26 x 10W G4 12V
-  Dimmable with IGBT and TRIAC
Dali system on request
- or on request**
-  LED
26 x 2W G4 12V
-  Dimmable with IGBT
Dali system on request
-  LED integrated
26 x 1,5W
-  Dimmable with 1-10V
and Dali

Canopy |

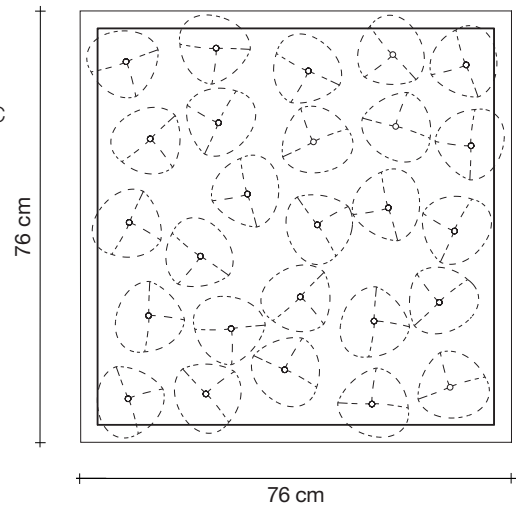

Inspired by the tranquil and mesmerizing light refractions created by water, Mizu is a customizable pendant light from Terzani. Like water droplets, no two Mizu are alike, each crystal shape is unique and made meticulously by hand. Using only the clearest crystal, Mizu perfectly emulates water's refraction of light, casting amazing patterns around the room, reminiscent of flowing water. Also available in gold leaf. Design Nicolas Terzani

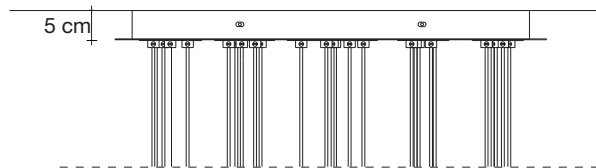

97cm x 92cm x 54cm

Mizu, Flowing *Light*.



design Nicolas Terzani
terzani.com



Type |
Suspension

Materials |
Clear crystal

Finishes | Code

-  Clear
OR26S E8 A9 T
-  Clear/Silver Dust
OR26S E8 F4 T
-  Clear/Gold
OR26S E8 A4 T

White canopy

Body |

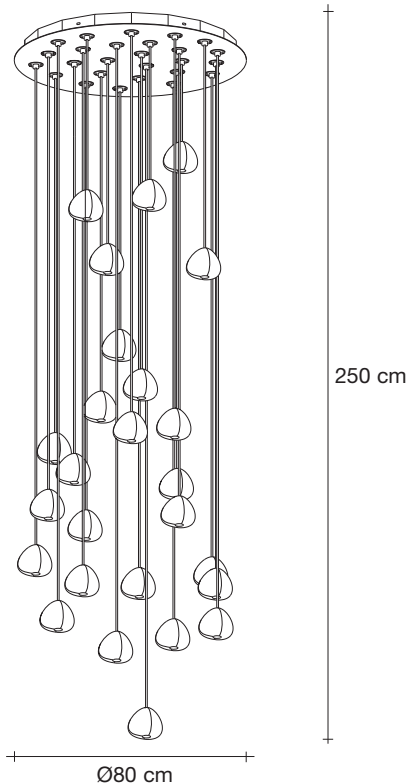



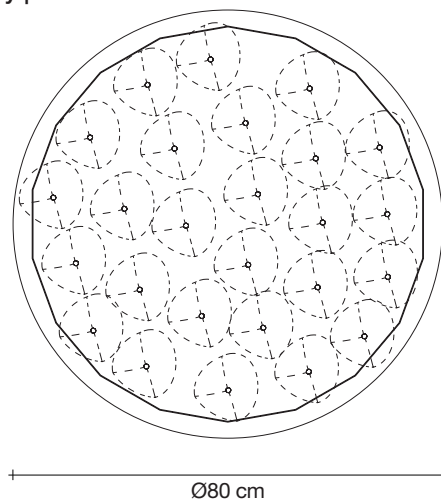



Canopy |



Light Source |

230-240V ~ 50/60Hz

-  HALOGEN
26 x 10W G4 12V
-  Dimmable with IGBT and TRIAC
Dali system on request
- **or on request**

-  LED
26 x 2W G4 12V
-  Dimmable with IGBT
Dali system on request
-
-  LED integrated
26 x 1,5W
-  Dimmable with 1-10V
and Dali

Inspired by the tranquil and mesmerizing light refractions created by water, Mizu is a customizable pendant light from Terzani. Like water droplets, no two Mizu are alike, each crystal shape is unique and made meticulously by hand. Using only the clearest crystal, Mizu perfectly emulates water's refraction of light, casting amazing patterns around the room, reminiscent of flowing water. Also available in gold leaf. Design Nicolas Terzani

