

# TECHNICAL DATA SHEET

## MASK 111 IP20

INDOOR - INTERNO - INNENBEREICH - INTERIEUR - INTÉRIEUR - INTERIOR

Adjustable  $\odot$  0° - 30°

$\square$  274x429 mm

Material : CALCYT® plaster

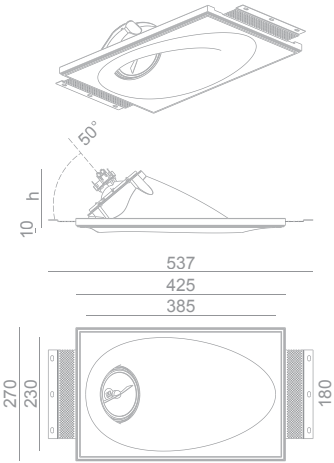

### MASK 111 LED 3000LM CRI 80

REF N°	2700°K	3000°K	4000°K
on/off	240 26 040	240 26 140	240 26 240
DIM 1-10V	240 66 040	240 66 140	240 66 240
DIM DALI	240 36 040	240 36 140	240 36 240

Xicato LED - 29,3W - 3000lm - 2 Step MacAdam  
 $\square$  - 230V/50Hz -  $\text{CE}$  -  $\nabla$  -  $\text{A}$   
 Beam angle 36° (option 20°) - Incl LED driver  
 h = 155 mm

### MASK 111 LED 2000LM CRI 80

REF N°	2700°K	3000°K	4000°K
on/off	240 25 040	240 25 140	240 25 240
phase DIM	240 75 040	240 75 140	240 75 240
DIM 1-10V	240 65 040	240 65 140	240 65 240
DIM DALI	240 35 040	240 35 140	240 35 240

Xicato LED - 19,5W - 2000lm - 2 Step MacAdam  
 $\square$  - 230V/50Hz -  $\text{CE}$  -  $\nabla$  -  $\text{A}$   
 Beam 36° (option 20°) - Incl LED driver  
 h = 155 mm

### MASK 111 LED 1300LM CRI 97

REF N°	2700°K	3000°K	4000°K
on/off	240 23 940	240 23 840	240 23 740
phase DIM	240 73 940	240 73 840	240 73 740
DIM 1-10V	240 63 940	240 63 840	240 63 740
DIM DALI	240 33 940	240 33 840	240 33 740

Xicato LED - 17,6W - 1300lm - 2 Step MacAdam  
 $\square$  - 230V/50Hz -  $\text{CE}$  -  $\nabla$  -  $\text{A}$   
 Beam angle 36° (option 20°) - Incl LED driver  
 h = 155 mm

### MASK 111 LED 2000LM CRI 97

REF N°	2700°K	3000°K	4000°K
on/off	240 25 940	240 25 840	240 25 740
phase DIM	240 75 940	240 75 840	240 75 740
DIM 1-10V	240 65 940	240 65 840	240 65 740
DIM DALI	240 35 940	240 35 840	240 35 740

Xicato LED - 22,3W - 2000lm - 2 Step MacAdam  
 $\square$  - 230V/50Hz -  $\text{CE}$  -  $\nabla$  -  $\text{A}$   
 Beam angle 36° (option 20°) - Incl LED driver  
 h = 155 mm

### MASK 111 AR

REF N° 240 13 100

$\square$  QR-LP 111 - 100W - G53 - 12V -  $\text{CE}$   
 excl. transfo -  $\text{CE}$  -  $\nabla$  -  $\text{A}$   
 h = 119 mm

### MASK 111 CDM

REF N° 240 19 070 CDM-TC - G8,5  
 REF N° 240 12 070 CDM-R - GX8,5

35W or 70W - 230V/50Hz -  $\text{CE}$  -  $\nabla$  -  $\text{A}$   
 h = 148 mm -  $\text{CE}$  -  $\nabla$  -  $\text{A}$

### INSTALLATION KIT

**STANDARD** (included) installation system for ceiling 9 - 12 - 15 mm  
**REF N° 240 99 025** installation system for gypsum ceiling 25 mm  
**REF N° 240 99 030** installation system for gypsum ceiling 30 mm  
**REF N° 840 00 000** Concrete box Mask 111 - Galvanized steel

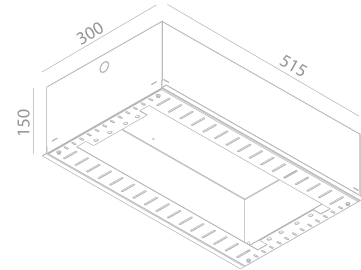

### BEAM ANGLES & OPTIONS

**STANDARD** (included) beam angle 36°  
**REF N° 205 11 020** optional beam angle 20°  
**REF N° 201 00 060** Frosted diffusor for 111 LED series

### EMERGENCY UNITS

**REF N° 693 01 001** 1h basic + control LED  
**REF N° 693 01 003** 3h basic + control LED  
**REF N° 693 30 001** 1h EMPRO DALI  
**REF N° 693 30 003** 3h EMPRO DALI



# TECHNICAL DATA SHEET

## MASK 50 IP54

BATHROOM - STANZA DA BAGNO - BADEZIMMER - BADKAMER - SALLE DE BAINS - CUARTO DE BAÑO

Fix (not adjustable) 0° - 0°

192x269 mm

Material : CALCYT® plaster

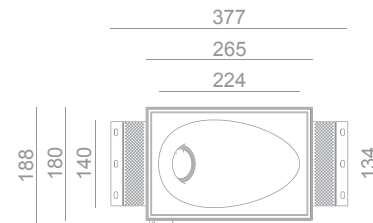
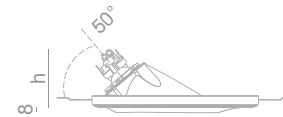
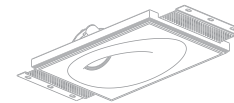

MASK 50 LED WARM DIM		
WARM DIM : DIMS FROM 3000°K TO 2000°K		
REF N°	500LM CRI80	900LM CRI90
phase DIM	241 72 641	241 73 641
DIM 1-10V	241 62 641	241 63 641
DIM DALI	241 32 641	241 33 641

6 W (500lm) - 12,8 W (900lm) - 4 Step MacAdam  
 □ - 230V/50Hz - CE - ▽ - ⚡ - B  
 Incl. LED driver (phase DIM, 1-10V or DALI)  
 Standard beam angle 36° (options 24°)  
 h = 115 mm (500lm) - h = 150 mm (900lm)

MASK 50 LED 1300LM CRI 80			
REF N°	2700°K	3000°K	4000°K
phase DIM	241 73 041	241 73 141	241 73 241
DIM 1-10V	241 63 041	241 63 141	241 63 241
DIM DALI	241 33 041	241 33 141	241 33 241

Xicato LED - 11,7 W - 1300lm - 2 Step MacAdam  
 □ - 230V/50Hz - CE - ▽ - ⚡ - A  
 Incl. LED driver (phase DIM, 1-10V or DALI)  
 Standard beam angle 36° (options 12°, 24°)  
 h = 150 mm

MASK 50 LED 700LM CRI 80			
REF N°	2700°K	3000°K	4000°K
phase DIM	241 72 041	241 72 141	241 72 241
DIM 1-10V	241 62 041	241 62 141	241 62 241
DIM DALI	241 32 041	241 32 141	241 32 241

Xicato LED - 5,6 W - 720lm - 2 Step MacAdam  
 □ - 230V/50Hz - CE - ▽ - ⚡ - A+  
 Incl. LED driver (phase DIM, 1-10V or DALI)  
 Standard beam angle 36° (options 12°, 24°)  
 h = 92 mm (phase DIM models beam 36°)  
 h = 115 mm (all other models)

MASK 50 LED 700LM CRI 97			
REF N°	2700°K	3000°K	4000°K
phase DIM	241 72 941	241 72 841	241 72 741
DIM 1-10V	241 62 941	241 62 841	241 62 741
DIM DALI	241 32 941	241 32 841	241 32 741

Xicato LED - 7,4 W - 720lm - 2 Step MacAdam  
 □ - 230V/50Hz - CE - ▽ - ⚡ - A  
 Incl. LED driver (phase DIM, 1-10V or DALI)  
 Standard beam angle 36° (options 12°, 24°)  
 h = 115 mm (models beam angle 36°)  
 h = 150 mm (models beam angle 12° or 24°)

MASK 50 HAL	
REF N° 241 10 051	
⚡ QR-CBC 51 - 50W - Gx5.3 - 12V ◊ - CE - ⚡ - ▽ - ⓪.5m - D h = 92 mm - exclusive lamp and transfo	

MASK 50 ES	
REF N° 241 11 051	
⚡ QPAR 16 - 50W - GZ10/GU10 - ⚡ ◊ - CE - 230V/50Hz - ▽ - ⓪.5m - D h = 93 mm - exclusive lamp	

### INSTALLATION KIT

- STANDARD** (included) installation system for ceiling 9 - 12 - 15 mm  
**REF N° 241 99 025** installation system for gypsum ceiling 25 mm  
**REF N° 241 99 030** installation system for gypsum ceiling 30 mm  
**REF N° 841 00 000** Concrete box Mask 50 - Galvanized steel

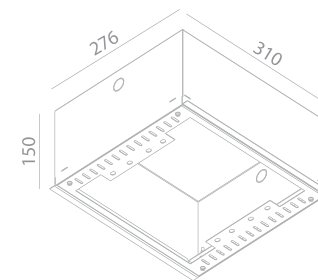

### BEAM ANGLES

- STANDARD** (included) beam angle 36°  
**REF N° 205 50 012** optional beam angle 12°  
**REF N° 205 50 024** optional beam angle 24°

### EMERGENCY UNITS

- REF N° 693 01 001** 1h basic + control LED  
**REF N° 693 01 003** 3h basic + control LED  
**REF N° 693 30 001** 1h EMPRO DALI  
**REF N° 693 30 003** 3h EMPRO DALI



# TECHNICAL DATA SHEET

## MASK 50 IP54

OUTDOOR - ESTERNO - AUßENBEREICH - EXTERIEUR - EXTÉRIEUR - EXTERIOR

Fix (not adjustable) 0° - 0°

192x269 mm

Material : waterproof CALCYT+®

### MASK 50 LED WARMDIM

WARMDIM : DIMS FROM 3000°K TO 2000°K

REF N°	500LM CRI80	900LM CRI90
phase DIM	241 72 645	241 73 645
DIM 1-10V	241 62 645	241 63 645
DIM DALI	241 32 645	241 33 645

6 W (500lm) - 12,8 W (900lm) - 4 Step MacAdam  
 □ - 230V/50Hz - - - -   
 Incl. LED driver (phase DIM, 1-10V or DALI)  
 Standard beam angle 36° (options 24°)  
 h = 115 mm (500lm) - h = 150 mm (900lm)

### MASK 50 LED 1300LM CRI 80

REF N°	2700°K	3000°K	4000°K
phase DIM	241 73 045	241 73 145	241 73 245
DIM 1-10V	241 63 045	241 63 145	241 63 245
DIM DALI	241 33 045	241 33 145	241 33 245

Xicato LED - 11,7 W - 1300lm - 2 Step MacAdam  
 □ - 230V/50Hz - - - -   
 Incl. LED driver (phase DIM, 1-10V or DALI)  
 Standard beam angle 36° (options 12°, 24°)  
 h = 150 mm

### MASK 50 LED 700LM CRI 80

REF N°	2700°K	3000°K	4000°K
phase DIM	241 72 045	241 72 145	241 72 245
DIM 1-10V	241 62 045	241 62 145	241 62 245
DIM DALI	241 32 045	241 32 145	241 32 245

Xicato LED - 5,6 W - 720lm - 2 Step MacAdam  
 □ - 230V/50Hz - - - -   
 Incl. LED driver (phase DIM, 1-10V or DALI)  
 Standard beam angle 36° (options 12°, 24°)  
 h = 92 mm (phase DIM models beam 36°)  
 h = 115 mm (all other models)

### MASK 50 LED 700LM CRI 97

REF N°	2700°K	3000°K	4000°K
phase DIM	241 72 945	241 72 845	241 72 745
DIM 1-10V	241 62 945	241 62 845	241 62 745
DIM DALI	241 32 945	241 32 845	241 32 745

Xicato LED - 7,4 W - 720lm - 2 Step MacAdam  
 □ - 230V/50Hz - - - -   
 Incl. LED driver (phase DIM, 1-10V or DALI)  
 Standard beam angle 36° (options 12°, 24°)  
 h = 115 mm (models beam angle 36°)  
 h = 150 mm (models beam angle 12° or 24°)

### MASK 50 HAL

REF N° 241 10 055

QR-CBC 51 - 50W - Gx5.3 - 12V  
 - - - - -   
 h = 92 mm - exclusive lamp and transfo

### MASK 50 ES

REF N° 241 11 055

QPAR 16 - 50W - GZ10/GU10 - -   
 - - 230V/50Hz - - -   
 h = 93 mm - exclusive lamp

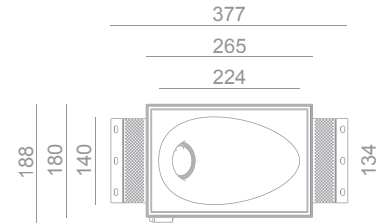
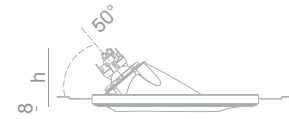
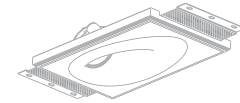

### INSTALLATION KIT

- STANDARD** (included) installation system for ceiling 9 - 12 - 15 mm
- REF N° 241 99 025** installation system for gypsum ceiling 25 mm
- REF N° 241 99 030** installation system for gypsum ceiling 30 mm
- REF N° 841 00 000** Concrete box Mask 50 - Galvanized steel

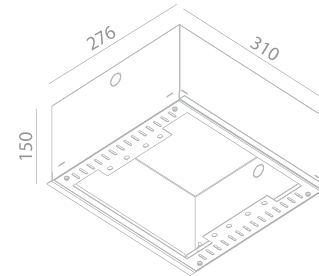

### BEAM ANGLES

- STANDARD** (included) beam angle 36°
- REF N° 205 50 012** optional beam angle 12°
- REF N° 205 50 024** optional beam angle 24°

### EMERGENCY UNITS

- REF N° 693 01 001** 1h basic + control LED
- REF N° 693 01 003** 3h basic + control LED
- REF N° 693 30 001** 1h EMPRO DALI
- REF N° 693 30 003** 3h EMPRO DALI

# TECHNICAL DATA SHEET

## MASK 50 IP20

INDOOR - INTERNO - INNENBEREICH - INTERIEUR - INTÉRIEUR - INTERIOR

Adjustable  $\varnothing$  0° - 30°

192x269 mm

Material : CALCYT® plaster

### MASK 50 LED WARMDIM

WARMDIM : DIMS FROM 3000°K TO 2000°K

REF N°	500LM CRI80	900LM CRI90
phase DIM	241 72 640	241 73 640
DIM 1-10V	241 62 640	241 63 640
DIM DALI	241 32 640	241 33 640

6W (500lm) - 12,8W (900lm) - 4 Step MacAdam  
 $\square$  - 230V/50Hz -  $\text{CE}$  -  $\nabla$  -  $\text{A}$  -  $\text{B}$   
 Incl. LED driver (phase DIM, 1-10V or DALI)  
 Standard beam angle 36° (options 24°)  
 h = 115 mm (500lm) - h = 150 mm (900lm)

### MASK 50 LED 1300LM CRI 80

REF N°	2700°K	3000°K	4000°K
phase DIM	241 73 040	241 73 140	241 73 240
DIM 1-10V	241 63 040	241 63 140	241 63 240
DIM DALI	241 33 040	241 33 140	241 33 240

Xicato LED - 11,7W - 1300lm - 2 Step MacAdam  
 $\square$  - 230V/50Hz -  $\text{CE}$  -  $\nabla$  -  $\text{A}$   
 Incl. LED driver (phase DIM, 1-10V or DALI)  
 Standard beam angle 36° (options 12°, 24°)  
 h = 150 mm

### MASK 50 LED 700LM CRI 80

REF N°	2700°K	3000°K	4000°K
phase DIM	241 72 040	241 72 140	241 72 240
DIM 1-10V	241 62 040	241 62 140	241 62 240
DIM DALI	241 32 040	241 32 140	241 32 240

Xicato LED - 5,6 W - 720lm - 2 Step MacAdam  
 $\square$  - 230V/50Hz -  $\text{CE}$  -  $\nabla$  -  $\text{A}^+$   
 Incl. LED driver (phase DIM, 1-10V or DALI)  
 Standard beam angle 36° (options 12°, 24°)  
 h = 92 mm (phase DIM models beam 36°)  
 h = 115 mm (all other models)

### MASK 50 LED 700LM CRI 97

REF N°	2700°K	3000°K	4000°K
phase DIM	241 72 940	241 72 840	241 72 740
DIM 1-10V	241 62 940	241 62 840	241 62 740
DIM DALI	241 32 940	241 32 840	241 32 740

Xicato LED - 7,4 W - 720lm - 2 Step MacAdam  
 $\square$  - 230V/50Hz -  $\text{CE}$  -  $\nabla$  -  $\text{A}^+$   
 Incl. LED driver (phase DIM, 1-10V or DALI)  
 Standard beam angle 36° (options 12°, 24°)  
 h = 115 mm (models beam angle 36°)  
 h = 150 mm (models beam angle 12° or 24°)

### MASK 50 HAL

REF N° 241 10 050

$\text{QR-CBC}$  51 - 50W - Gx5,3 - 12V  
 $\text{CE}$  -  $\nabla$  -  $\text{D}$  -  $\text{D}$   
 h = 92 mm - exclusive lamp and transfo

### MASK 50 ES

REF N° 241 11 050

$\text{QPAR}$  16 - 50W - GZ10/GU10 -  $\text{A}$   
 $\text{CE}$  - 230V/50Hz -  $\nabla$  -  $\text{D}$  -  $\text{D}$   
 h = 93 mm - exclusive lamp

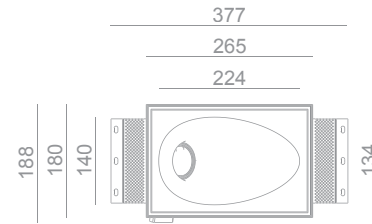
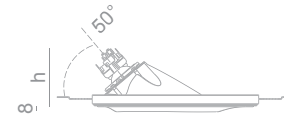
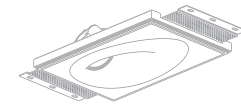

### INSTALLATION KIT

- STANDARD** (included) installation system for ceiling 9 - 12 - 15 mm
- REF N° 241 99 025 installation system for gypsum ceiling 25 mm
- REF N° 241 99 030 installation system for gypsum ceiling 30 mm
- REF N° 841 00 000 Concrete box Mask 50 - Galvanized steel

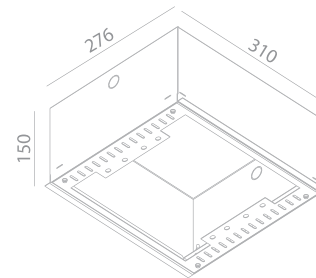

### BEAM ANGLES

- STANDARD** (included) beam angle 36°
- REF N° 205 50 012 optional beam angle 12°
- REF N° 205 50 024 optional beam angle 24°

### EMERGENCY UNITS

- REF N° 693 01 001 1h basic + control LED
- REF N° 693 01 003 3h basic + control LED
- REF N° 693 30 001 1h EMPRO DALI
- REF N° 693 30 003 3h EMPRO DALI

# MASK 50 IP20

ACCESSORIES - ACCESSORI - ZUBEHÖR - ACCESSOIRES - ACCESORIOS



**STANDARD** (included) LAMPHOLDER RING WHITE



**REF N° 201 10 002** LAMPHOLDER RING BLACK



**REF N° 201 11 001**  
EXTENSION S WHITE  
Ø 56 x 26 mm ⌀ 0° - 10°



**REF N° 201 12 001**  
EXTENSION M WHITE  
Ø 56 x 36 mm ⌀ 0° - 10°



**REF N° 201 13 001**  
EXTENSION L WHITE  
Ø 56 x 68 mm ⌀ 0° - 10°



**REF N° 201 11 002**  
EXTENSION S BLACK  
Ø 56 x 26 mm ⌀ 0° - 10°



**REF N° 201 12 002**  
EXTENSION M BLACK  
Ø 56 x 36 mm ⌀ 0° - 10°



**REF N° 201 13 002**  
EXTENSION L BLACK  
Ø 56 x 68 mm ⌀ 0° - 10°



**REF N° 201 51 001**  
FROSTED PLEXI WHITE  
Only for LED lampsources



**REF N° 201 52 001**  
HONEYCOMB WHITE  
Only for LED lampsources



**REF N° 201 53 001**  
SPHERICAL GLASS LENS  
IN WHITE RING



**REF N° 201 51 002**  
FROSTED PLEXI BLACK  
Only for LED lampsources



**REF N° 201 52 002**  
HONEYCOMB BLACK  
Only for LED lampsources



**REF N° 201 53 002**  
SPHERICAL GLASS LENS  
IN BLACK RING