

TECHNICAL DATA SHEET

PICA ZERO IP54

OUTDOOR - ESTERNO - AUßENBEREICH - EXTERIEUR - EXTÉRIEUR - EXTERIOR

Fix (not adjustable) 0° - 0°

132x132 mm

Material : waterproof CALCYT+® and frosted diffusor

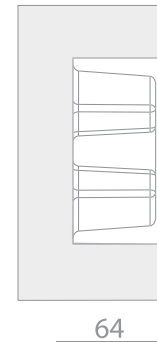
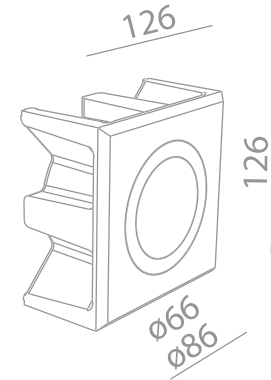

REMOTE LED DRIVER ON/OFF

REF N° 697 00 006 8W

REF N° 697 00 015 15W

REF N° 697 00 025 25W

230V/50Hz - - current controlled

- - IP20 - 350mA - not dimmable

PICA ZERO LED DIM 100 LM

REF N° 128 60 505 CRI 80 warm white 2200°K

REF N° 128 60 005 CRI 90 warm white 2700°K

REF N° 128 60 105 CRI 90 warm white 3000°K

REF N° 128 60 205 CRI 90 neutral white 4000°K

REF N° 128 60 305 royal blue

- 1W - excl. LED driver - current controlled 350 mA - - -
 - - serial wiring - 3 Step MacAdam
Requires remote LED driver - 350 mA

REMOTE LED DRIVER DIM

REF N° 697 60 006 6W 1-10V

REF N° 697 60 015 15W 1-10V

REF N° 697 30 015 15W DALI

REF N° 697 60 025 25W 1-10V DALI PUSH

REF N° 697 60 040 40W 1-10V DALI PUSH

REF N° 697 70 009 9W PHASE DIM (tr. edge)

REF N° 697 70 017 17W PHASE DIM

230V/50Hz - - current controlled

- - IP20 - 350mA - dimmable

PICA ZERO LED DIM 200 LM

REF N° 128 62 505 CRI 80 warm white 2200°K

REF N° 128 62 005 CRI 90 warm white 2700°K

REF N° 128 62 105 CRI 90 warm white 3000°K

REF N° 128 62 205 CRI 90 neutral white 4000°K

REF N° 128 62 305 royal blue

- 2W - excl. LED driver - current controlled 350 mA - - -
 - - serial wiring - 3 Step MacAdam
Requires remote LED driver - 350 mA

PICA ZERO LED DIM 400 LM

REF N° 128 61 505 CRI 80 warm white 2200°K

REF N° 128 61 005 CRI 90 warm white 2700°K

REF N° 128 61 105 CRI 90 warm white 3000°K

REF N° 128 61 205 CRI 90 neutral white 4000°K

REF N° 128 61 305 royal blue

- 4W - excl. LED driver - current controlled 350 mA - - -
 - - serial wiring - 3 Step MacAdam
Requires remote LED driver - 350 mA

Ready for installation in solid walls
Optional plasterkit for installation into gypsum walls

PLASTERKIT PICA ZERO
REF N° 725 01 000 For mounting into gypsum walls
Housing: perforated aluminium

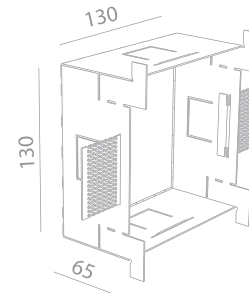



TECHNICAL DATA SHEET

PICA ZERO IP54

BATHROOM - STANZA DA BAGNO - BADEZIMMER - BADKAMER - SALLE DE BAINS - CUARTO DE BAÑO

Fix (not adjustable) 0° - 0°

132x132 mm



Material : CALCYT® plaster and frosted diffusor

REMOTE LED DRIVER ON/OFF

REF N° 697 00 006 8W

REF N° 697 00 015 15W

REF N° 697 00 025 25W

230V/50Hz -  - current controlled
 -  - IP20 - 350mA - not dimmable

PICA ZERO LED DIM 100 LM







REF N° 128 60 501 CRI 80 warm white 2200°K

REF N° 128 60 001 CRI 90 warm white 2700°K

REF N° 128 60 101 CRI 90 warm white 3000°K

REF N° 128 60 201 CRI 90 neutral white 4000°K

REF N° 128 60 301 royal blue

 - 1W - excl. LED driver - current controlled 350 mA -  -  - 
 -  - serial wiring - 3 Step MacAdam
 Requires remote LED driver - 350 mA

REMOTE LED DRIVER DIM

REF N° 697 60 006 6W 1-10V

REF N° 697 60 015 15W 1-10V



REF N° 697 30 015 15W DALI

REF N° 697 60 025 25W 1-10V DALI PUSH

REF N° 697 60 040 40W 1-10V DALI PUSH

REF N° 697 70 009 9W PHASE DIM (tr. edge)

REF N° 697 70 017 17W PHASE DIM

230V/50Hz -  - current controlled
 -  - IP20 - 350mA - dimmable

PICA ZERO LED DIM 200 LM







REF N° 128 62 501 CRI 80 warm white 2200°K

REF N° 128 62 001 CRI 90 warm white 2700°K

REF N° 128 62 101 CRI 90 warm white 3000°K

REF N° 128 62 201 CRI 90 neutral white 4000°K

REF N° 128 62 301 royal blue

 - 2W - excl. LED driver - current controlled 350 mA -  -  - 
 -  - serial wiring - 3 Step MacAdam
 Requires remote LED driver - 350 mA

PICA ZERO LED DIM 400 LM







REF N° 128 61 501 CRI 80 warm white 2200°K

REF N° 128 61 001 CRI 90 warm white 2700°K

REF N° 128 61 101 CRI 90 warm white 3000°K

REF N° 128 61 201 CRI 90 neutral white 4000°K

REF N° 128 61 301 royal blue

 - 4W - excl. LED driver - current controlled 350 mA -  -  - 
 -  - serial wiring - 3 Step MacAdam
 Requires remote LED driver - 350 mA

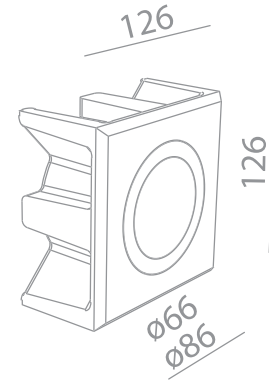

Ready for installation in solid walls
 Optional plasterkit for installation into gypsum walls

PLASTERKIT PICA ZERO
REF N° 725 01 000 For mounting into gypsum walls
 Housing: perforated aluminium

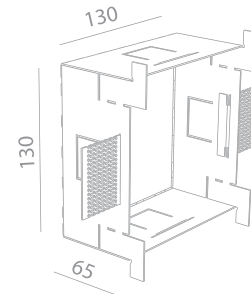

TECHNICAL DATA SHEET

PICA ZERO IP20

INDOOR - INTERNO - INNENBEREICH - INTERIEUR - INTÉRIEUR - INTERIOR

Fix (not adjustable) 0° - 0°

132x132 mm

Material : CALCYT® plaster and frosted diffusor

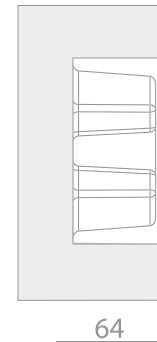
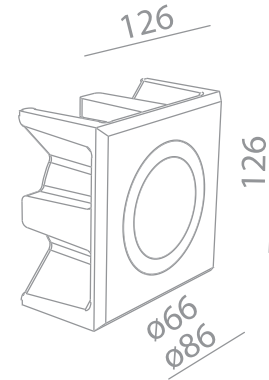

REMOTE LED DRIVER ON/OFF

REF N° 697 00 006 8W

REF N° 697 00 015 15W

REF N° 697 00 025 25W

230V/50Hz - - current controlled

- - IP20 - 350mA - not dimmable

PICA ZERO LED DIM 100 LM

REF N° 128 60 500 CRI 80 warm white 2200°K

REF N° 128 60 000 CRI 90 warm white 2700°K

REF N° 128 60 100 CRI 90 warm white 3000°K

REF N° 128 60 200 CRI 90 neutral white 4000°K

REF N° 128 60 300 royal blue

- 1W - excl. LED driver - current controlled 350 mA - - - - - - serial wiring - 3 Step MacAdam
Requires remote LED driver - 350 mA

REMOTE LED DRIVER DIM

REF N° 697 60 006 6W 1-10V

REF N° 697 60 015 15W 1-10V

REF N° 697 30 015 15W DALI

REF N° 697 60 025 25W 1-10V DALI PUSH

REF N° 697 60 040 40W 1-10V DALI PUSH

REF N° 697 70 009 9W PHASE DIM (tr. edge)

REF N° 697 70 017 17W PHASE DIM

230V/50Hz - - current controlled

- - IP20 - 350mA - dimmable

PICA ZERO LED DIM 200 LM

REF N° 128 62 500 CRI 80 warm white 2200°K

REF N° 128 62 000 CRI 90 warm white 2700°K

REF N° 128 62 100 CRI 90 warm white 3000°K

REF N° 128 62 200 CRI 90 neutral white 4000°K

REF N° 128 62 300 royal blue

- 2W - excl. LED driver - current controlled 350 mA - - - - - - serial wiring - 3 Step MacAdam
Requires remote LED driver - 350 mA

PICA ZERO LED DIM 400 LM

REF N° 128 61 500 CRI 80 warm white 2200°K

REF N° 128 61 000 CRI 90 warm white 2700°K

REF N° 128 61 100 CRI 90 warm white 3000°K

REF N° 128 61 200 CRI 90 neutral white 4000°K

REF N° 128 61 300 royal blue

- 4W - excl. LED driver - current controlled 350 mA - - - - - - serial wiring - 3 Step MacAdam
Requires remote LED driver - 350 mA

Ready for installation in solid walls
Optional plasterkit for installation into gypsum walls

PLASTERKIT PICA ZERO
REF N° 725 01 000 For mounting into gypsum walls
Housing: perforated aluminium

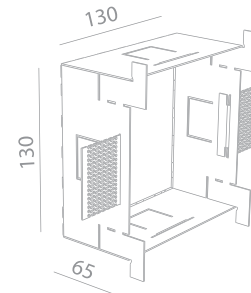

TECHNICAL DATA SHEET

PICA 8 IP54

BATHROOM - STANZA DA BAGNO - BADEZIMMER - BADKAMER - SALLE DE BAINS - CUARTO DE BAÑO

Fix (not adjustable) 0° - 0°

132x132 mm



Material : CALCYT® plaster and frosted diffusor

REMOTE LED DRIVER ON/OFF

REF N° 697 00 006 8W

REF N° 697 00 015 15W

REF N° 697 00 025 25W

230V/50Hz -  - current controlled
 -  - IP20 - 350mA - not dimmable

PICA 8 LED DIM 100 LM







REF N° 125 60 501 CRI 80 warm white 2200°K

REF N° 125 60 001 CRI 90 warm white 2700°K

REF N° 125 60 101 CRI 90 warm white 3000°K

REF N° 125 60 201 CRI 90 neutral white 4000°K

REF N° 125 60 301 royal blue

 - 1W - excl. LED driver - current controlled 350 mA -  -  - 
 -  - serial wiring - 3 Step MacAdam
 Requires remote LED driver - 350 mA

REMOTE LED DRIVER DIM

REF N° 697 60 006 6W 1-10V

REF N° 697 60 015 15W 1-10V



REF N° 697 30 015 15W DALI

REF N° 697 60 025 25W 1-10V DALI PUSH

REF N° 697 60 040 40W 1-10V DALI PUSH

REF N° 697 70 009 9W PHASE DIM (tr. edge)

REF N° 697 70 017 17W PHASE DIM

230V/50Hz -  - current controlled
 -  - IP20 - 350mA - dimmable

PICA 8 LED DIM 200 LM







REF N° 125 62 501 CRI 80 warm white 2200°K

REF N° 125 62 001 CRI 90 warm white 2700°K

REF N° 125 62 101 CRI 90 warm white 3000°K

REF N° 125 62 201 CRI 90 neutral white 4000°K

REF N° 125 62 301 royal blue

 - 2W - excl. LED driver - current controlled 350 mA -  -  - 
 -  - serial wiring - 3 Step MacAdam
 Requires remote LED driver - 350 mA

PICA 8 LED DIM 400 LM







REF N° 125 61 501 CRI 80 warm white 2200°K

REF N° 125 61 001 CRI 90 warm white 2700°K

REF N° 125 61 101 CRI 90 warm white 3000°K

REF N° 125 61 201 CRI 90 neutral white 4000°K

REF N° 125 61 301 royal blue

 - 4W - excl. LED driver - current controlled 350 mA -  -  - 
 -  - serial wiring - 3 Step MacAdam
 Requires remote LED driver - 350 mA

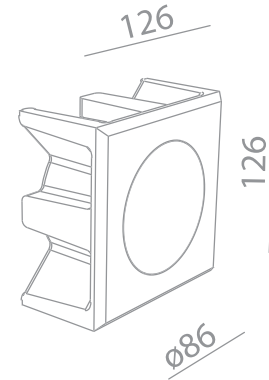

Ready for installation in solid walls
 Optional plasterkit for installation into gypsum walls

PLASTERKIT PICA 8
REF N° 725 01 000 For mounting into gypsum walls
 Housing: perforated aluminium

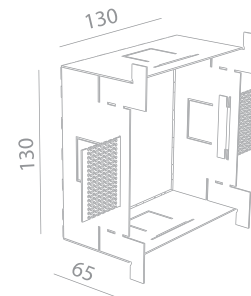

TECHNICAL DATA SHEET

PICA 8 IP20

INDOOR - INTERNO - INNENBEREICH - INTERIEUR - INTÉRIEUR - INTERIOR

Fix (not adjustable) 0° - 0°

132x132 mm

Material : CALCYT® plaster and frosted diffusor



REMOTE LED DRIVER ON/OFF

REF N° 697 00 006 8W

REF N° 697 00 015 15W

REF N° 697 00 025 25W

230V/50Hz -  - current controlled

 -  - IP20 - 350mA - not dimmable

PICA 8 LED DIM 100 LM







REF N° 125 60 500 CRI 80 warm white 2200°K

REF N° 125 60 000 CRI 90 warm white 2700°K

REF N° 125 60 100 CRI 90 warm white 3000°K

REF N° 125 60 200 CRI 90 neutral white 4000°K

REF N° 125 60 300 royal blue

 - 1W - excl. LED driver - current controlled 350 mA -  -  - 
 -  - serial wiring - 3 Step MacAdam
Requires remote LED driver - 350 mA

REMOTE LED DRIVER DIM

REF N° 697 60 006 6W 1-10V

REF N° 697 60 015 15W 1-10V

REF N° 697 30 015 15W DALI

REF N° 697 60 025 25W 1-10V DALI PUSH

REF N° 697 60 040 40W 1-10V DALI PUSH

REF N° 697 70 009 9W PHASE DIM (tr. edge)

REF N° 697 70 017 17W PHASE DIM

230V/50Hz -  - current controlled

 -  - IP20 - 350mA - dimmable

PICA 8 LED DIM 200 LM







REF N° 125 62 500 CRI 80 warm white 2200°K

REF N° 125 62 000 CRI 90 warm white 2700°K

REF N° 125 62 100 CRI 90 warm white 3000°K

REF N° 125 62 200 CRI 90 neutral white 4000°K

REF N° 125 62 300 royal blue

 - 2W - excl. LED driver - current controlled 350 mA -  -  - 
 -  - serial wiring - 3 Step MacAdam
Requires remote LED driver - 350 mA

PICA 8 LED DIM 400 LM







REF N° 125 61 500 CRI 80 warm white 2200°K

REF N° 125 61 000 CRI 90 warm white 2700°K

REF N° 125 61 100 CRI 90 warm white 3000°K

REF N° 125 61 200 CRI 90 neutral white 4000°K

REF N° 125 61 300 royal blue

 - 4W - excl. LED driver - current controlled 350 mA -  -  - 
 -  - serial wiring - 3 Step MacAdam
Requires remote LED driver - 350 mA

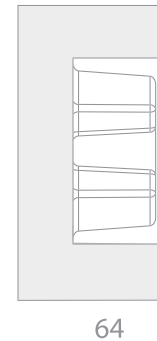
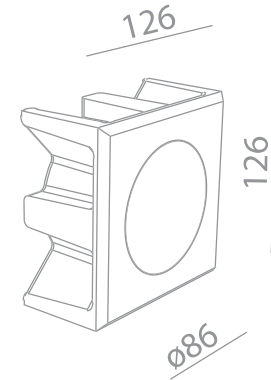

Ready for installation in solid walls
Optional plasterkit for installation into gypsum walls

PLASTERKIT PICA 8
REF N° 725 01 000 For mounting into gypsum walls
Housing: perforated aluminium

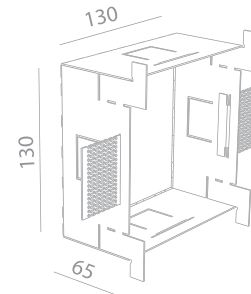

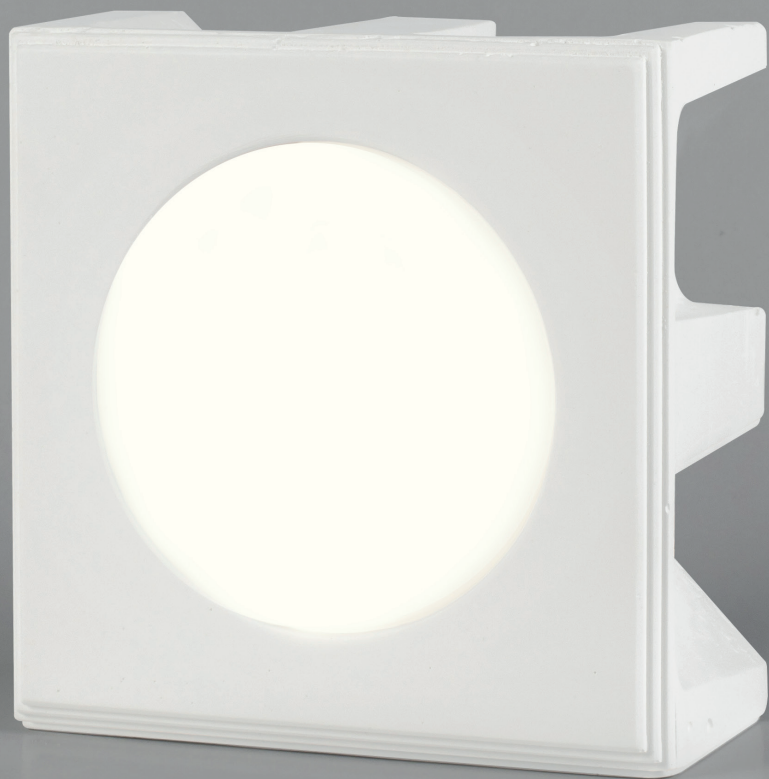

TECHNICAL DATA SHEET

PICA 3 IP54

BATHROOM - STANZA DA BAGNO - BADEZIMMER - BADKAMER - SALLE DE BAINS - CUARTO DE BAÑO

Fix (not adjustable) 0° - 0°

85x85 mm

Material : CALCYT® plaster and frosted diffuser

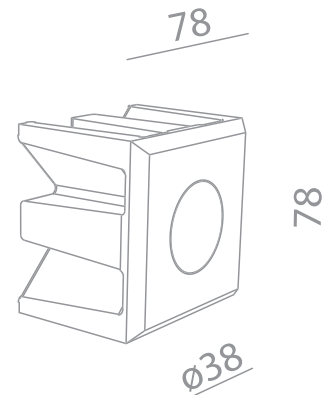

PICA 3 LED DIM 100 LM

REF N° 124 60 501 CRI 80 warm white 2200°K

REF N° 124 60 001 CRI 90 warm white 2700°K

REF N° 124 60 101 CRI 90 warm white 3000°K

REF N° 124 60 201 CRI 90 neutral white 4000°K

REF N° 124 60 301 royal blue

◊ - 1W - excl. LED driver - current controlled 350 mA - ▽ - A - E
 CE - P - serial wiring - 3 Step MacAdam
 Requires remote LED driver - 350 mA

REMOTE LED DRIVER ON/OFF

REF N° 697 00 006 8W

REF N° 697 00 015 15W

REF N° 697 00 025 25W

230V/50Hz - □ - current controlled
 ▽ - CE - IP20 - 350mA - not dimmable

PICA 3 LED DIM 200 LM

REF N° 124 62 501 CRI 80 warm white 2200°K

REF N° 124 62 001 CRI 90 warm white 2700°K

REF N° 124 62 101 CRI 90 warm white 3000°K

REF N° 124 62 201 CRI 90 neutral white 4000°K

REF N° 124 62 301 royal blue

◊ - 2W - excl. LED driver - current controlled 350 mA - ▽ - A - E
 CE - P - serial wiring - 3 Step MacAdam
 Requires remote LED driver - 350 mA

REMOTE LED DRIVER DIM

REF N° 697 60 006 6W 1-10V

REF N° 697 60 015 15W 1-10V

REF N° 697 30 015 15W DALI

REF N° 697 60 025 25W 1-10V DALI PUSH

REF N° 697 60 040 40W 1-10V DALI PUSH

REF N° 697 70 009 9W PHASE DIM (tr. edge)

REF N° 697 70 017 17W PHASE DIM

230V/50Hz - □ - current controlled
 ▽ - CE - IP20 - 350mA - dimmable

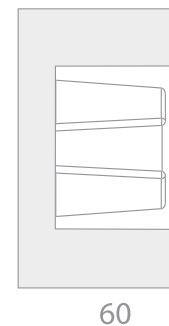

Ready for installation in solid walls
 Optional plasterkit for installation into gypsum walls

PLASTERKIT PICA 3

REF N° 724 01 000 For mounting into gypsum walls
 Housing: perforated aluminium

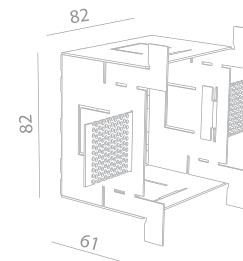

TECHNICAL DATA SHEET

PICA 8 IP54

OUTDOOR - ESTERNO - AUßENBEREICH - EXTERIEUR - EXTÉRIEUR - EXTERIOR

Fix (not adjustable) 0° - 0°

132x132 mm

Material : waterproof CALCYT+® and frosted diffusor

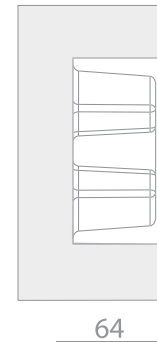
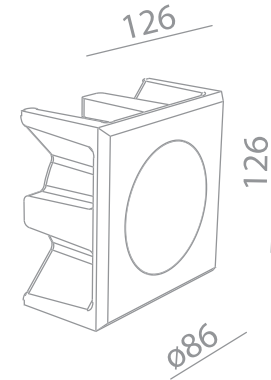

REMOTE LED DRIVER ON/OFF

REF N° 697 00 006 8W

REF N° 697 00 015 15W

REF N° 697 00 025 25W

230V/50Hz - - current controlled

- - IP20 - 350mA - not dimmable

PICA 8 LED DIM 100 LM

REF N° 125 60 505 CRI 80 warm white 2200°K

REF N° 125 60 005 CRI 90 warm white 2700°K

REF N° 125 60 105 CRI 90 warm white 3000°K

REF N° 125 60 205 CRI 90 neutral white 4000°K

REF N° 125 60 305 royal blue

- 1W - excl. LED driver - current controlled 350 mA - - -
 - - serial wiring - 3 Step MacAdam
Requires remote LED driver - 350 mA

REMOTE LED DRIVER DIM

REF N° 697 60 006 6W 1-10V

REF N° 697 60 015 15W 1-10V

REF N° 697 30 015 15W DALI

REF N° 697 60 025 25W 1-10V DALI PUSH

REF N° 697 60 040 40W 1-10V DALI PUSH

REF N° 697 70 009 9W PHASE DIM (tr. edge)

REF N° 697 70 017 17W PHASE DIM

230V/50Hz - - current controlled

- - IP20 - 350mA - dimmable

PICA 8 LED DIM 200 LM

REF N° 125 62 505 CRI 80 warm white 2200°K

REF N° 125 62 005 CRI 90 warm white 2700°K

REF N° 125 62 105 CRI 90 warm white 3000°K

REF N° 125 62 205 CRI 90 neutral white 4000°K

REF N° 125 62 305 royal blue

- 2W - excl. LED driver - current controlled 350 mA - - -
 - - serial wiring - 3 Step MacAdam
Requires remote LED driver - 350 mA

PICA 8 LED DIM 400 LM

REF N° 125 61 505 CRI 80 warm white 2200°K

REF N° 125 61 005 CRI 90 warm white 2700°K

REF N° 125 61 105 CRI 90 warm white 3000°K

REF N° 125 61 205 CRI 90 neutral white 4000°K

REF N° 125 61 305 royal blue

- 4W - excl. LED driver - current controlled 350 mA - - -
 - - serial wiring - 3 Step MacAdam
Requires remote LED driver - 350 mA

Ready for installation in solid walls
Optional plasterkit for installation into gypsum walls

PLASTERKIT PICA 8
REF N° 725 01 000 For mounting into gypsum walls
Housing: perforated aluminium

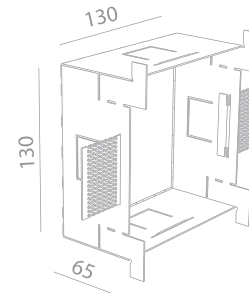

TECHNICAL DATA SHEET

PICA 3 IP20

INDOOR - INTERNO - INNENBEREICH - INTERIEUR - INTÉRIEUR - INTERIOR

Fix (not adjustable) 0° - 0°

85x85 mm

Material : CALCYT® plaster and frosted diffuser

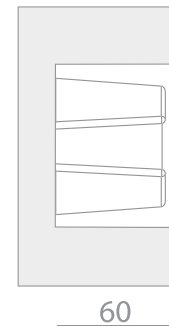
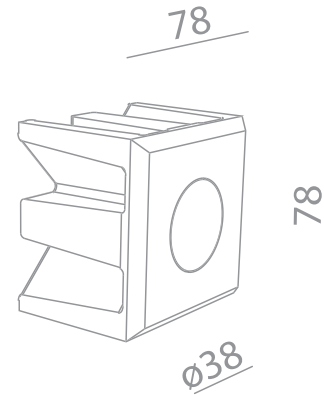

PICA 3 LED DIM 100 LM

REF N° 124 60 500 CRI 80 warm white 2200°K

REF N° 124 60 000 CRI 90 warm white 2700°K

REF N° 124 60 100 CRI 90 warm white 3000°K

REF N° 124 60 200 CRI 90 neutral white 4000°K

REF N° 124 60 300 royal blue

◊ - 1W - excl. LED driver - current controlled 350 mA - ▽ - A - E

CE - P - serial wiring - 3 Step MacAdam
Requires remote LED driver - 350 mA

REMOTE LED DRIVER ON/OFF

REF N° 697 00 006 8W

REF N° 697 00 015 15W

REF N° 697 00 025 25W

230V/50Hz - □ - current controlled
▽ - CE - IP20 - 350mA - not dimmable

PICA 3 LED DIM 200 LM

REF N° 124 62 500 CRI 80 warm white 2200°K

REF N° 124 62 000 CRI 90 warm white 2700°K

REF N° 124 62 100 CRI 90 warm white 3000°K

REF N° 124 62 200 CRI 90 neutral white 4000°K

REF N° 124 62 300 royal blue

◊ - 2W - excl. LED driver - current controlled 350 mA - ▽ - A - E

CE - P - serial wiring - 3 Step MacAdam
Requires remote LED driver - 350 mA

REMOTE LED DRIVER DIM

REF N° 697 60 006 6W 1-10V

REF N° 697 60 015 15W 1-10V

REF N° 697 30 015 15W DALI

REF N° 697 60 025 25W 1-10V DALI PUSH

REF N° 697 60 040 40W 1-10V DALI PUSH

REF N° 697 70 009 9W PHASE DIM (tr. edge)

REF N° 697 70 017 17W PHASE DIM

230V/50Hz - □ - current controlled
▽ - CE - IP20 - 350mA - dimmable

Ready for installation in solid walls
Optional plasterkit for installation into gypsum walls

PLASTERKIT PICA 3

REF N° 724 01 000 For mounting into gypsum walls
Housing: perforated aluminium

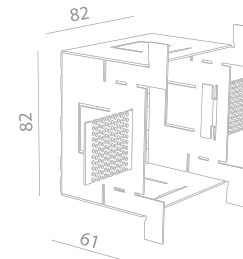

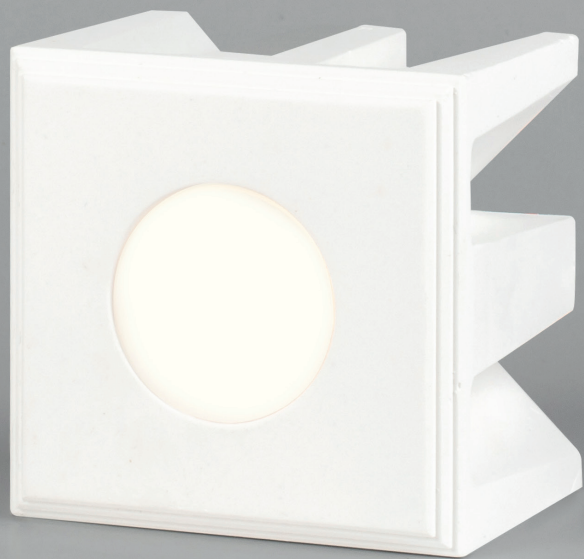

TECHNICAL DATA SHEET

PICA 3 IP54

OUTDOOR - ESTERNO - AUßENBEREICH - EXTERIEUR - EXTÉRIEUR - EXTERIOR

Fix (not adjustable) 0° - 0°

85x85 mm

Material : waterproof CALCYT+® and frosted diffuser

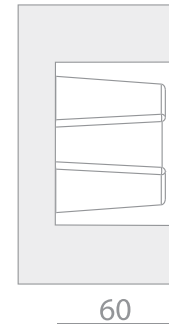
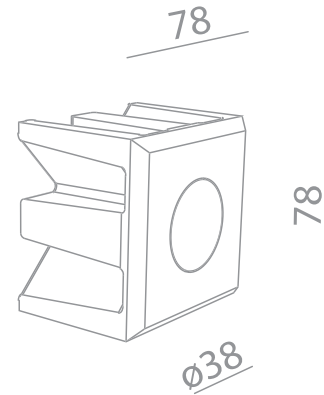

Ready for installation in solid walls
Optional plasterkit for installation into gypsum walls

PLASTERKIT PICA 3

REF N° 724 01 000 For mounting into gypsum walls
Housing: perforated aluminium

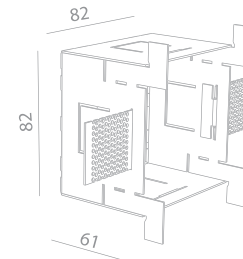

PICA 3 LED DIM 100 LM

REF N° 124 60 505 CRI 80 warm white 2200°K

REF N° 124 60 005 CRI 90 warm white 2700°K

REF N° 124 60 105 CRI 90 warm white 3000°K

REF N° 124 60 205 CRI 90 neutral white 4000°K

REF N° 124 60 305 royal blue

◊ - 1W - excl. LED driver - current controlled 350 mA - ▽ - A - E

CE - P - serial wiring - 3 Step MacAdam
Requires remote LED driver - 350 mA

REMOTE LED DRIVER ON/OFF

REF N° 697 00 006 8W

REF N° 697 00 015 15W

REF N° 697 00 025 25W

230V/50Hz - □ - current controlled
▽ - CE - IP20 - 350mA - not dimmable

PICA 3 LED DIM 200 LM

REF N° 124 62 505 CRI 80 warm white 2200°K

REF N° 124 62 005 CRI 90 warm white 2700°K

REF N° 124 62 105 CRI 90 warm white 3000°K

REF N° 124 62 205 CRI 90 neutral white 4000°K

REF N° 124 62 305 royal blue

◊ - 2W - excl. LED driver - current controlled 350 mA - ▽ - A - E

CE - P - serial wiring - 3 Step MacAdam
Requires remote LED driver - 350 mA

REMOTE LED DRIVER DIM

REF N° 697 60 006 6W 1-10V

REF N° 697 60 015 15W 1-10V

REF N° 697 30 015 15W DALI

REF N° 697 60 025 25W 1-10V DALI PUSH

REF N° 697 60 040 40W 1-10V DALI PUSH

REF N° 697 70 009 9W PHASE DIM (tr. edge)

REF N° 697 70 017 17W PHASE DIM

230V/50Hz - □ - current controlled
▽ - CE - IP20 - 350mA - dimmable