

TECHNICAL DATA SHEET

STRIPP XL IP54

BATHROOM - STANZA DA BAGNO - BADEZIMMER - BADKAMER - SALLE DE BAINS - CUARTO DE BAÑO

Fix (not adjustable) 0° - 0°

83x550 mm



Material : CALCYT® plaster

REMOTE LED DRIVER ON/OFF

REF N° 697 00 006 8W

REF N° 697 00 015 15W

REF N° 697 00 025 25W

230V/50Hz -  - current controlled
 -  - IP20 - 350mA - not dimmable

STRIPP XL LED DIM 100 LM







REF N° 143 60 501 CRI 80 warm white 2200°K

REF N° 143 60 001 CRI 90 warm white 2700°K

REF N° 143 60 101 CRI 90 warm white 3000°K

REF N° 143 60 201 CRI 90 neutral white 4000°K

REF N° 143 60 301 royal blue

 - 1W - excl. LED driver - current controlled 350 mA -  -  -  -  -  - serial wiring - 3 Step MacAdam
 Requires remote LED driver - 350 mA

REMOTE LED DRIVER DIM

REF N° 697 60 006 6W 1-10V

REF N° 697 60 015 15W 1-10V



REF N° 697 30 015 15W DALI

REF N° 697 60 025 25W 1-10V DALI PUSH

REF N° 697 60 040 40W 1-10V DALI PUSH

REF N° 697 70 009 9W PHASE DIM (tr. edge)

REF N° 697 70 017 17W PHASE DIM

230V/50Hz -  - current controlled
 -  - IP20 - 350mA - dimmable

STRIPP XL LED DIM 200 LM







REF N° 143 62 501 CRI 80 warm white 2200°K

REF N° 143 62 001 CRI 90 warm white 2700°K

REF N° 143 62 101 CRI 90 warm white 3000°K

REF N° 143 62 201 CRI 90 neutral white 4000°K

REF N° 143 62 301 royal blue

 - 2W - excl. LED driver - current controlled 350 mA -  -  -  -  -  - serial wiring - 3 Step MacAdam
 Requires remote LED driver - 350 mA

STRIPP XL LED DIM 400 LM







REF N° 143 61 501 CRI 80 warm white 2200°K

REF N° 143 61 001 CRI 90 warm white 2700°K

REF N° 143 61 101 CRI 90 warm white 3000°K

REF N° 143 61 201 CRI 90 neutral white 4000°K

REF N° 143 61 301 royal blue

 - 4W - excl. LED driver - current controlled 350 mA -  -  -  -  -  - serial wiring - 3 Step MacAdam
 Requires remote LED driver - 350 mA

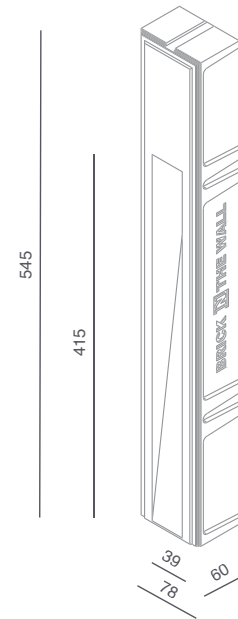

Ready for installation in solid walls
 Optional plasterkit for installation into gypsum walls

PLASTERKIT STRIPP XL

REF N° 743 01 000 For mounting into gypsum walls

Housing: perforated aluminium

TECHNICAL DATA SHEET

STRIPP XF IP54

OUTDOOR - ESTERNO - AUßENBEREICH - EXTERIEUR - EXTÉRIEUR - EXTERIOR

Fix (not adjustable) 0° - 0°

83x550 mm

Material : waterproof CALCYT+®

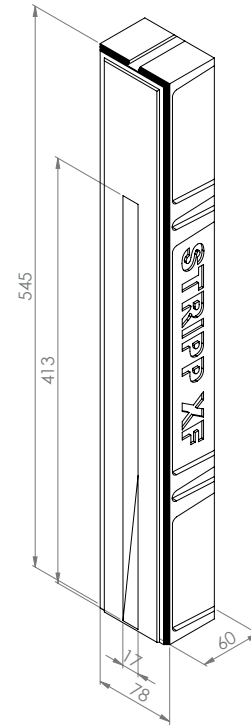

REMOTE LED DRIVER ON/OFF

REF N° 697 00 006 8W

REF N° 697 00 015 15W

REF N° 697 00 025 25W

230V/50Hz - - current controlled

- - IP20 - 350mA - not dimmable

STRIPP XF LED DIM 100 LM

REF N° 141 60 505 CRI 80 warm white 2200°K

REF N° 141 60 005 CRI 90 warm white 2700°K

REF N° 141 60 105 CRI 90 warm white 3000°K

REF N° 141 60 205 CRI 90 neutral white 4000°K

REF N° 141 60 305 royal blue

- 1W - excl. LED driver - current controlled 350 mA - - -

- - serial wiring - 3 Step MacAdam
Requires remote LED driver - 350 mA

REMOTE LED DRIVER DIM

REF N° 697 60 006 6W 1-10V

REF N° 697 60 015 15W 1-10V

REF N° 697 30 015 15W DALI

REF N° 697 60 025 25W 1-10V DALI PUSH

REF N° 697 60 040 40W 1-10V DALI PUSH

REF N° 697 70 009 9W PHASE DIM (tr. edge)

REF N° 697 70 017 17W PHASE DIM

230V/50Hz - - current controlled

- - IP20 - 350mA - dimmable

Ready for installation in solid walls
Optional plasterkit for installation into gypsum walls

PLASTERKIT STRIPP XF

REF N° 743 01 000 For mounting into gypsum walls

Housing: perforated aluminium



TECHNICAL DATA SHEET

STRIPP XL IP54

OUTDOOR - ESTERNO - AUßENBEREICH - EXTERIEUR - EXTÉRIEUR - EXTERIOR

Fix (not adjustable) 0° - 0°

83x550 mm



Material : waterproof CALCYT+®

REMOTE LED DRIVER ON/OFF

REF N° 697 00 006 8W

REF N° 697 00 015 15W

REF N° 697 00 025 25W

230V/50Hz -  - current controlled
 -  - IP20 - 350mA - not dimmable

STRIPP XL LED DIM 100 LM







REF N° 143 60 505 CRI 80 warm white 2200°K

REF N° 143 60 005 CRI 90 warm white 2700°K

REF N° 143 60 105 CRI 90 warm white 3000°K

REF N° 143 60 205 CRI 90 neutral white 4000°K

REF N° 143 60 305 royal blue

 - 1W - excl. LED driver - current controlled 350 mA -  -  -  -  -  - serial wiring - 3 Step MacAdam
 Requires remote LED driver - 350 mA

REMOTE LED DRIVER DIM

REF N° 697 60 006 6W 1-10V

REF N° 697 60 015 15W 1-10V



REF N° 697 30 015 15W DALI

REF N° 697 60 025 25W 1-10V DALI PUSH

REF N° 697 60 040 40W 1-10V DALI PUSH

REF N° 697 70 009 9W PHASE DIM (tr. edge)

REF N° 697 70 017 17W PHASE DIM

230V/50Hz -  - current controlled
 -  - IP20 - 350mA - dimmable

STRIPP XL LED DIM 200 LM







REF N° 143 62 505 CRI 80 warm white 2200°K

REF N° 143 62 005 CRI 90 warm white 2700°K

REF N° 143 62 105 CRI 90 warm white 3000°K

REF N° 143 62 205 CRI 90 neutral white 4000°K

REF N° 143 62 305 royal blue

 - 2W - excl. LED driver - current controlled 350 mA -  -  -  -  -  - serial wiring - 3 Step MacAdam
 Requires remote LED driver - 350 mA

STRIPP XL LED DIM 400 LM







REF N° 143 61 505 CRI 80 warm white 2200°K

REF N° 143 61 005 CRI 90 warm white 2700°K

REF N° 143 61 105 CRI 90 warm white 3000°K

REF N° 143 61 205 CRI 90 neutral white 4000°K

REF N° 143 61 305 royal blue

 - 4W - excl. LED driver - current controlled 350 mA -  -  -  -  -  - serial wiring - 3 Step MacAdam
 Requires remote LED driver - 350 mA

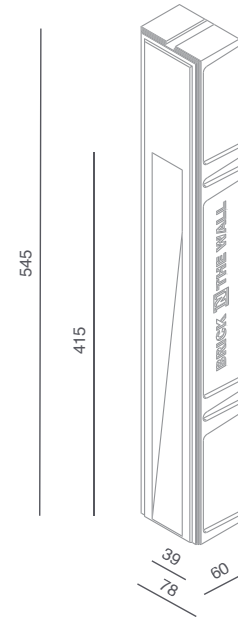

Ready for installation in solid walls
 Optional plasterkit for installation into gypsum walls

PLASTERKIT STRIPP XL

REF N° 743 01 000 For mounting into gypsum walls

Housing: perforated aluminium

TECHNICAL DATA SHEET

STRIPP XL IP20

INDOOR - INTERNO - INNENBEREICH - INTERIEUR - INTÉRIEUR - INTERIOR

Fix (not adjustable) 0° - 0°

83x550 mm



Material : CALCYT® plaster

REMOTE LED DRIVER ON/OFF

REF N° 697 00 006 8W

REF N° 697 00 015 15W

REF N° 697 00 025 25W

230V/50Hz -  - current controlled
 -  - IP20 - 350mA - not dimmable

STRIPP XL LED DIM 100 LM







REF N° 143 60 500 CRI 80 warm white 2200°K

REF N° 143 60 000 CRI 90 warm white 2700°K

REF N° 143 60 100 CRI 90 warm white 3000°K

REF N° 143 60 200 CRI 90 neutral white 4000°K

REF N° 143 60 300 royal blue

 - 1W - excl. LED driver - current controlled 350 mA -  -  -  -  -  - serial wiring - 3 Step MacAdam
Requires remote LED driver - 350 mA

REMOTE LED DRIVER DIM

REF N° 697 60 006 6W 1-10V

REF N° 697 60 015 15W 1-10V



REF N° 697 30 015 15W DALI

REF N° 697 60 025 25W 1-10V DALI PUSH

REF N° 697 60 040 40W 1-10V DALI PUSH

REF N° 697 70 009 9W PHASE DIM (tr. edge)

REF N° 697 70 017 17W PHASE DIM

230V/50Hz -  - current controlled
 -  - IP20 - 350mA - dimmable

STRIPP XL LED DIM 200 LM







REF N° 143 62 500 CRI 80 warm white 2200°K

REF N° 143 62 000 CRI 90 warm white 2700°K

REF N° 143 62 100 CRI 90 warm white 3000°K

REF N° 143 62 200 CRI 90 neutral white 4000°K

REF N° 143 62 300 royal blue

 - 2W - excl. LED driver - current controlled 350 mA -  -  -  -  -  - serial wiring - 3 Step MacAdam
Requires remote LED driver - 350 mA

STRIPP XL LED DIM 400 LM







REF N° 143 61 500 CRI 80 warm white 2200°K

REF N° 143 61 000 CRI 90 warm white 2700°K

REF N° 143 61 100 CRI 90 warm white 3000°K

REF N° 143 61 200 CRI 90 neutral white 4000°K

REF N° 143 61 300 royal blue

 - 4W - excl. LED driver - current controlled 350 mA -  -  -  -  -  - serial wiring - 3 Step MacAdam
Requires remote LED driver - 350 mA

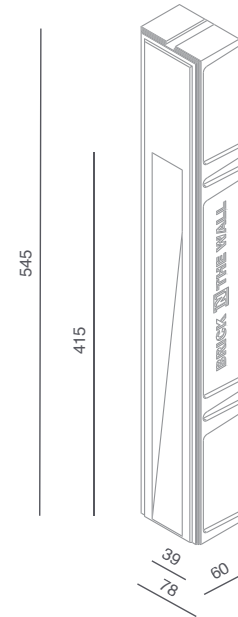

Ready for installation in solid walls
Optional plasterkit for installation into gypsum walls

PLASTERKIT STRIPP XL
REF N° 743 01 000 For mounting into gypsum walls
Housing: perforated aluminium



BRICK IN THE WALL

TECHNICAL DATA SHEET

STRIPP XF IP54

BATHROOM - STANZA DA BAGNO - BADEZIMMER - BADKAMER - SALLE DE BAINS - CUARTO DE BAÑO

Fix (not adjustable) 0° - 0°

83x550 mm

Material : CALCYT® plaster

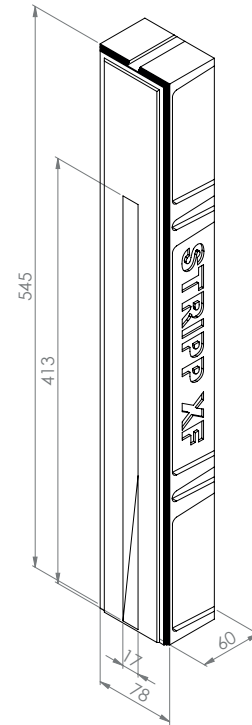

REMOTE LED DRIVER ON/OFF

REF N° 697 00 006 8W

REF N° 697 00 015 15W

REF N° 697 00 025 25W

230V/50Hz - - current controlled
 - - IP20 - 350mA - not dimmable

STRIPP XF LED DIM 100 LM

REF N° 141 60 501 CRI 80 warm white 2200°K

REF N° 141 60 001 CRI 90 warm white 2700°K

REF N° 141 60 101 CRI 90 warm white 3000°K

REF N° 141 60 201 CRI 90 neutral white 4000°K

REF N° 141 60 301 royal blue

- 1W - excl. LED driver - current controlled 350 mA - - -
 - - serial wiring - 3 Step MacAdam
Requires remote LED driver - 350 mA

REMOTE LED DRIVER DIM

REF N° 697 60 006 6W 1-10V

REF N° 697 60 015 15W 1-10V

REF N° 697 30 015 15W DALI

REF N° 697 60 025 25W 1-10V DALI PUSH

REF N° 697 60 040 40W 1-10V DALI PUSH

REF N° 697 70 009 9W PHASE DIM (tr. edge)

REF N° 697 70 017 17W PHASE DIM

230V/50Hz - - current controlled
 - - IP20 - 350mA - dimmable

Ready for installation in solid walls
Optional plasterkit for installation into gypsum walls

PLASTERKIT STRIPP XF

REF N° 743 01 000 For mounting into gypsum walls

Housing: perforated aluminium

TECHNICAL DATA SHEET

STRIPP XF IP20

INDOOR - INTERNO - INNENBEREICH - INTERIEUR - INTÉRIEUR - INTERIOR

Fix (not adjustable) 0° - 0°

83x550 mm

Material : CALCYT® plaster

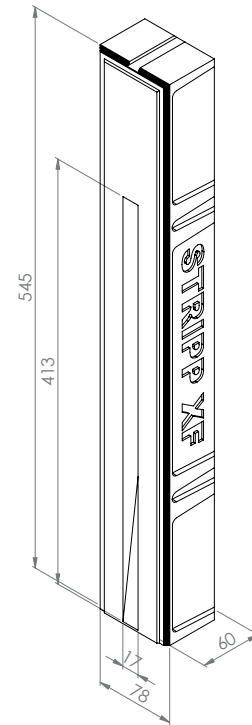

REMOTE LED DRIVER ON/OFF

REF N° 697 00 006 8W

REF N° 697 00 015 15W

REF N° 697 00 025 25W

230V/50Hz - - current controlled

- - IP20 - 350mA - not dimmable

STRIPP XF LED DIM 100 LM

REF N° 141 60 500 CRI 80 warm white 2200°K

REF N° 141 60 000 CRI 90 warm white 2700°K

REF N° 141 60 100 CRI 90 warm white 3000°K

REF N° 141 60 200 CRI 90 neutral white 4000°K

REF N° 141 60 300 royal blue

- 1W - excl. LED driver - current controlled 350 mA - - -

- - serial wiring - 3 Step MacAdam
Requires remote LED driver - 350 mA

REMOTE LED DRIVER DIM

REF N° 697 60 006 6W 1-10V

REF N° 697 60 015 15W 1-10V

REF N° 697 30 015 15W DALI

REF N° 697 60 025 25W 1-10V DALI PUSH

REF N° 697 60 040 40W 1-10V DALI PUSH

REF N° 697 70 009 9W PHASE DIM (tr. edge)

REF N° 697 70 017 17W PHASE DIM

230V/50Hz - - current controlled

- - IP20 - 350mA - dimmable

Ready for installation in solid walls
Optional plasterkit for installation into gypsum walls

PLASTERKIT STRIPP XF

REF N° 743 01 000 For mounting into gypsum walls

Housing: perforated aluminium

TECHNICAL DATA SHEET

STRIPP F IP54

OUTDOOR - ESTERNO - AUßENBEREICH - EXTERIEUR - EXTÉRIEUR - EXTERIOR

Fix (not adjustable) 0° - 0°

83x249 mm

Material : waterproof CALCYT+®

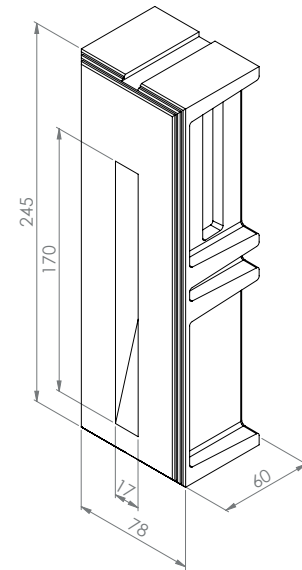

REMOTE LED DRIVER ON/OFF

REF N° 697 00 006 8W

REF N° 697 00 015 15W

REF N° 697 00 025 25W

230V/50Hz - - current controlled

- - IP20 - 350mA - not dimmable

STRIPP F LED DIM 100 LM

REF N° 142 60 505 CRI 80 warm white 2200°K

REF N° 142 60 005 CRI 90 warm white 2700°K

REF N° 142 60 105 CRI 90 warm white 3000°K

REF N° 142 60 205 CRI 90 neutral white 4000°K

REF N° 142 60 305 royal blue

- 1W - excl. LED driver - current controlled 350 mA - - -

- - serial wiring - 3 Step MacAdam
Requires remote LED driver - 350 mA

REMOTE LED DRIVER DIM

REF N° 697 60 006 6W 1-10V

REF N° 697 60 015 15W 1-10V

REF N° 697 30 015 15W DALI

REF N° 697 60 025 25W 1-10V DALI PUSH

REF N° 697 60 040 40W 1-10V DALI PUSH

REF N° 697 70 009 9W PHASE DIM (tr. edge)

REF N° 697 70 017 17W PHASE DIM

230V/50Hz - - current controlled

- - IP20 - 350mA - dimmable

Ready for installation in solid walls
Optional plasterkit for installation into gypsum walls

PLASTERKIT STRIPP F
REF N° 744 01 000 For mounting into gypsum walls
Housing: perforated aluminium

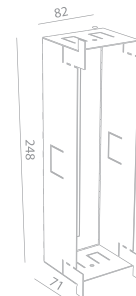



TECHNICAL DATA SHEET

STRIPP IP54

OUTDOOR - ESTERNO - AUßENBEREICH - EXTERIEUR - EXTERIOR

Fix (not adjustable) 0° - 0°

83x249 mm

Material : waterproof CALCYT+®

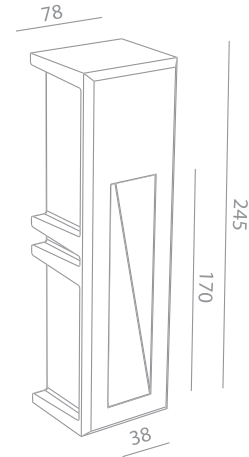

REMOTE LED DRIVER ON/OFF

REF N° 697 00 006 8W

REF N° 697 00 015 15W

REF N° 697 00 025 25W

230V/50Hz - - current controlled

- - IP20 - 350mA - not dimmable

STRIPP LED DIM 100 LM

REF N° 144 60 505 CRI 80 warm white 2200°K

REF N° 144 60 005 CRI 90 warm white 2700°K

REF N° 144 60 105 CRI 90 warm white 3000°K

REF N° 144 60 205 CRI 90 neutral white 4000°K

REF N° 144 60 305 royal blue

- 1W - excl. LED driver - current controlled 350 mA - - -
 - - serial wiring - 3 Step MacAdam
Requires remote LED driver - 350 mA

REMOTE LED DRIVER DIM

REF N° 697 60 006 6W 1-10V

REF N° 697 60 015 15W 1-10V

REF N° 697 30 015 15W DALI

REF N° 697 60 025 25W 1-10V DALI PUSH

REF N° 697 60 040 40W 1-10V DALI PUSH

REF N° 697 70 009 9W PHASE DIM (tr. edge)

REF N° 697 70 017 17W PHASE DIM

230V/50Hz - - current controlled

- - IP20 - 350mA - dimmable

STRIPP LED DIM 200 LM

REF N° 144 62 505 CRI 80 warm white 2200°K

REF N° 144 62 005 CRI 90 warm white 2700°K

REF N° 144 62 105 CRI 90 warm white 3000°K

REF N° 144 62 205 CRI 90 neutral white 4000°K

REF N° 144 62 305 royal blue

- 2W - excl. LED driver - current controlled 350 mA - - -
 - - serial wiring - 3 Step MacAdam
Requires remote LED driver - 350 mA

STRIPP LED DIM 400 LM

REF N° 144 61 505 CRI 80 warm white 2200°K

REF N° 144 61 005 CRI 90 warm white 2700°K

REF N° 144 61 105 CRI 90 warm white 3000°K

REF N° 144 61 205 CRI 90 neutral white 4000°K

REF N° 144 61 305 royal blue

- 4W - excl. LED driver - current controlled 350 mA - - -
 - - serial wiring - 3 Step MacAdam
Requires remote LED driver - 350 mA

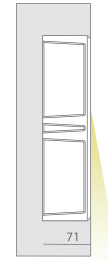

Ready for installation in solid walls
Optional plasterkit for installation into gypsum walls

PLASTERKIT STRIPP

REF N° 744 01 000 For mounting into gypsum walls

Housing: perforated aluminium

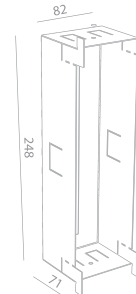

TECHNICAL DATA SHEET

STRIPP IP20

INDOOR - INTERNO - INNENBEREICH - INTERIEUR - INTÉRIEUR - INTERIOR

Fix (not adjustable) 0° - 0°

83x249 mm

Material : CALCYT® plaster

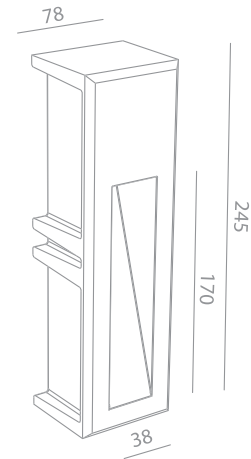

REMOTE LED DRIVER ON/OFF

REF N° 697 00 006 8W

REF N° 697 00 015 15W

REF N° 697 00 025 25W

230V/50Hz - - current controlled

- - IP20 - 350mA - not dimmable

STRIPP LED DIM 100 LM

REF N° 144 60 500 CRI 80 warm white 2200°K

REF N° 144 60 000 CRI 90 warm white 2700°K

REF N° 144 60 100 CRI 90 warm white 3000°K

REF N° 144 60 200 CRI 90 neutral white 4000°K

REF N° 144 60 300 royal blue

- 1W - excl. LED driver - current controlled 350 mA - - - - - - serial wiring - 3 Step MacAdam
Requires remote LED driver - 350 mA

REMOTE LED DRIVER DIM

REF N° 697 60 006 6W 1-10V

REF N° 697 60 015 15W 1-10V

REF N° 697 30 015 15W DALI

REF N° 697 60 025 25W 1-10V DALI PUSH

REF N° 697 60 040 40W 1-10V DALI PUSH

REF N° 697 70 009 9W PHASE DIM (tr. edge)

REF N° 697 70 017 17W PHASE DIM

230V/50Hz - - current controlled

- - IP20 - 350mA - dimmable

STRIPP LED DIM 200 LM

REF N° 144 62 500 CRI 80 warm white 2200°K

REF N° 144 62 000 CRI 90 warm white 2700°K

REF N° 144 62 100 CRI 90 warm white 3000°K

REF N° 144 62 200 CRI 90 neutral white 4000°K

REF N° 144 62 300 royal blue

- 2W - excl. LED driver - current controlled 350 mA - - - - - - serial wiring - 3 Step MacAdam
Requires remote LED driver - 350 mA

STRIPP LED DIM 400 LM

REF N° 144 61 500 CRI 80 warm white 2200°K

REF N° 144 61 000 CRI 90 warm white 2700°K

REF N° 144 61 100 CRI 90 warm white 3000°K

REF N° 144 61 200 CRI 90 neutral white 4000°K

REF N° 144 61 300 royal blue

- 4W - excl. LED driver - current controlled 350 mA - - - - - - serial wiring - 3 Step MacAdam
Requires remote LED driver - 350 mA

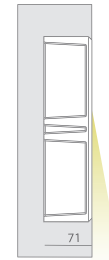

Ready for installation in solid walls
Optional plasterkit for installation into gypsum walls

PLASTERKIT STRIPP

REF N° 744 01 000 For mounting into gypsum walls

Housing: perforated aluminium





TECHNICAL DATA SHEET

STRIPP IP54

BATHROOM - STANZA DA BAGNO - BADEZIMMER - BADKAMER - SALLE DE BAINS - CUARTO DE BAÑO

Fix (not adjustable) 0° - 0°

83x249 mm

Material : CALCYT® plaster



REMOTE LED DRIVER ON/OFF

REF N° 697 00 006 8W

REF N° 697 00 015 15W

REF N° 697 00 025 25W

230V/50Hz -  - current controlled

 -  - IP20 - 350mA - not dimmable

STRIPP LED DIM 100 LM







REF N° 144 60 501 CRI 80 warm white 2200°K

REF N° 144 60 001 CRI 90 warm white 2700°K

REF N° 144 60 101 CRI 90 warm white 3000°K

REF N° 144 60 201 CRI 90 neutral white 4000°K

REF N° 144 60 301 royal blue

 - 1W - excl. LED driver - current controlled 350 mA -  -  -  -  -  - serial wiring - 3 Step MacAdam
Requires remote LED driver - 350 mA

REMOTE LED DRIVER DIM

REF N° 697 60 006 6W 1-10V

REF N° 697 60 015 15W 1-10V

REF N° 697 30 015 15W DALI

REF N° 697 60 025 25W 1-10V DALI PUSH

REF N° 697 60 040 40W 1-10V DALI PUSH

REF N° 697 70 009 9W PHASE DIM (tr. edge)

REF N° 697 70 017 17W PHASE DIM

230V/50Hz -  - current controlled

 -  - IP20 - 350mA - dimmable

STRIPP LED DIM 200 LM







REF N° 144 62 501 CRI 80 warm white 2200°K

REF N° 144 62 001 CRI 90 warm white 2700°K

REF N° 144 62 101 CRI 90 warm white 3000°K

REF N° 144 62 201 CRI 90 neutral white 4000°K

REF N° 144 62 301 royal blue

 - 2W - excl. LED driver - current controlled 350 mA -  -  -  -  -  - serial wiring - 3 Step MacAdam
Requires remote LED driver - 350 mA

STRIPP LED DIM 400 LM







REF N° 144 61 501 CRI 80 warm white 2200°K

REF N° 144 61 001 CRI 90 warm white 2700°K

REF N° 144 61 101 CRI 90 warm white 3000°K

REF N° 144 61 201 CRI 90 neutral white 4000°K

REF N° 144 61 301 royal blue

 - 4W - excl. LED driver - current controlled 350 mA -  -  -  -  -  - serial wiring - 3 Step MacAdam
Requires remote LED driver - 350 mA

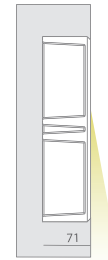
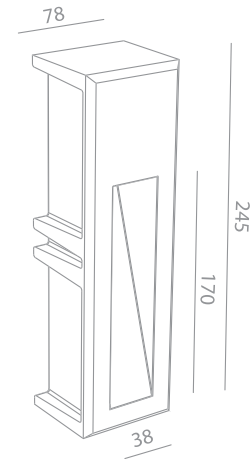

Ready for installation in solid walls
Optional plasterkit for installation into gypsum walls

PLASTERKIT STRIPP

REF N° 744 01 000 For mounting into gypsum walls

Housing: perforated aluminium

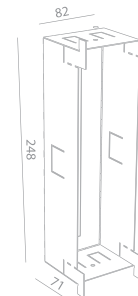

TECHNICAL DATA SHEET

STRIPP F IP54

BATHROOM - STANZA DA BAGNO - BADEZIMMER - BADKAMER - SALLE DE BAINS - CUARTO DE BAÑO

Fix (not adjustable) 0° - 0°

83x249 mm

Material : CALCYT® plaster

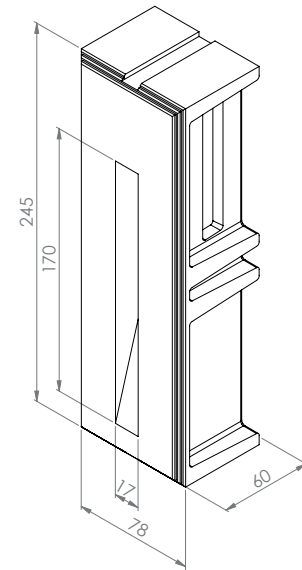

REMOTE LED DRIVER ON/OFF

REF N° 697 00 006 8W

REF N° 697 00 015 15W

REF N° 697 00 025 25W

230V/50Hz - - current controlled

- - IP20 - 350mA - not dimmable

STRIPP F LED DIM 100 LM

REF N° 142 60 501 CRI 80 warm white 2200°K

REF N° 142 60 001 CRI 90 warm white 2700°K

REF N° 142 60 101 CRI 90 warm white 3000°K

REF N° 142 60 201 CRI 90 neutral white 4000°K

REF N° 142 60 301 royal blue

- 1W - excl. LED driver - current controlled 350 mA - - -

- - serial wiring - 3 Step MacAdam

Requires remote LED driver - 350 mA

REMOTE LED DRIVER DIM

REF N° 697 60 006 6W 1-10V

REF N° 697 60 015 15W 1-10V

REF N° 697 30 015 15W DALI

REF N° 697 60 025 25W 1-10V DALI PUSH

REF N° 697 60 040 40W 1-10V DALI PUSH

REF N° 697 70 009 9W PHASE DIM (tr. edge)

REF N° 697 70 017 17W PHASE DIM

230V/50Hz - - current controlled

- - IP20 - 350mA - dimmable

Ready for installation in solid walls
Optional plasterkit for installation into gypsum walls

PLASTERKIT STRIPP F

REF N° 744 01 000 For mounting into gypsum walls

Housing: perforated aluminium

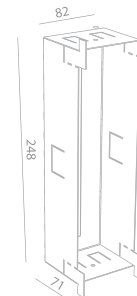

TECHNICAL DATA SHEET

STRIPP F IP20

INDOOR - INTERNO - INNENBEREICH - INTERIEUR - INTÉRIEUR - INTERIOR

Fix (not adjustable) 0° - 0°

83x249 mm

Material : CALCYT® plaster

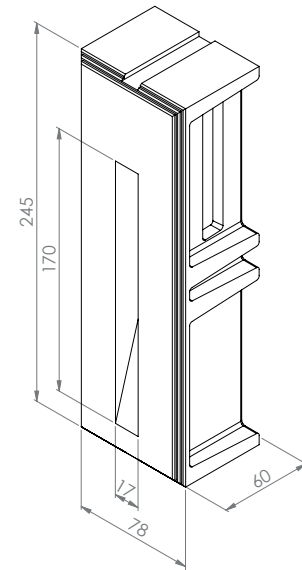

REMOTE LED DRIVER ON/OFF

REF N° 697 00 006 8W

REF N° 697 00 015 15W

REF N° 697 00 025 25W

230V/50Hz - - current controlled

- - IP20 - 350mA - not dimmable

STRIPP F LED DIM 100 LM

REF N° 142 60 500 CRI 80 warm white 2200°K

REF N° 142 60 000 CRI 90 warm white 2700°K

REF N° 142 60 100 CRI 90 warm white 3000°K

REF N° 142 60 200 CRI 90 neutral white 4000°K

REF N° 142 60 300 royal blue

- 1W - excl. LED driver - current controlled 350 mA - - -

- - serial wiring - 3 Step MacAdam

Requires remote LED driver - 350 mA

REMOTE LED DRIVER DIM

REF N° 697 60 006 6W 1-10V

REF N° 697 60 015 15W 1-10V

REF N° 697 30 015 15W DALI

REF N° 697 60 025 25W 1-10V DALI PUSH

REF N° 697 60 040 40W 1-10V DALI PUSH

REF N° 697 70 009 9W PHASE DIM (tr. edge)

REF N° 697 70 017 17W PHASE DIM

230V/50Hz - - current controlled

- - IP20 - 350mA - dimmable

Ready for installation in solid walls
Optional plasterkit for installation into gypsum walls

PLASTERKIT STRIPP F

REF N° 744 01 000 For mounting into gypsum walls

Housing: perforated aluminium

